



# CATÁLOGO DE PRODUCTOS

## SAUNA & VAPOR



# Índice

## Estufas para sauna

Línea Torre	1
SAWO30 Heaters	2
Tower Heaters	10
Aries Heaters	18
Cubos	26
Phoenix	29
Heaterking	31
Fiberjungle	34
Línea Suelo	35
Nordex Pro	36
Nordex Pro Combi	37
Nordex S	38
Nordex S Combi	39
Nordex Floor	40
Krios Floor	41
Helius	42
Taurus D	44
Taurus D Combi	46
Savonia	48
Savonia Combi	49
Línea Pared	50
Mini, Mini X and Mini Combi	51
Scandia	53
Scandia Combi	54
Krios	55
Nordex	57
Nordex Combi	58
Nordex Mini	59
Nordex Mini Combi	60
Scandifire	62
Minidragon	63
Línea Piedra	65
Nimbus	66
Nimbus Combi	67
Cumulus	68
Accesorios para estufas	69

## Paneles de control para Sauna

SAWO Sense	71
Saunova 2.0 PLUS	72
Saunova Controls	73
Innova Controls	74

## Accesorios para Sauna

Lotes de accesorios	78
Cubo de ducha	80
Cubos	81
Cucharones	82
Termómetros y medidores combinados	83
Relojes, relojes de arena, reposacabezas y respaldos	84
Mobiliario para sauna	85
Manillas de puerta y ventilación	86
Expositores y complementos	87
Puertas	88
Kivistone	90

## Generadores de Vapor

STN-S Generador de Vapor	92
STN-W Generador de Vapor	93
STN Generador de Vapor	94
STE Generador de Vapor	96
Controladores Generador de Vapor	98

# Estufas para SAUNA

Con más de 30 años de experiencia en la fabricación de productos para sauna, SAWO ofrece una amplia variedad de estufas eléctricas: línea Torre, línea Suelo, línea Pared y línea Piedra y la mayoría de los modelos están disponibles con vaporizador, llamado Combi.

Un buen punto de partida es definir el volumen de la sauna, la potencia (kW) correspondiente y el tipo de panel de control.

Todo lo demás dependerá del estilo de estufa y la preferencia personal de "löyly".

## Estufas para sauna Línea TORRE

Las estufas Torre de SAWO son auténticos "pilares de piedra para sauna". Su resistente estructura de acero inoxidable sostiene una gran cantidad de piedras y están diseñadas para que el vapor circule de forma uniforme desde la parte más baja hasta la más alta de la cabina.



# Modelo SAWO30

Las estufas eléctricas SAWO30 celebran los 30 años de trayectoria de la marca SAWO.

Diseñadas con precisión y elegancia, combinan un rendimiento potente con una estética moderna y con estilo.

El modelo SAWO30 se convierte en un elemento central llamativo para cualquier sauna y su altura garantiza una circulación de calor uniforme desde la parte inferior hasta la superior de la cabina. Las estufas eléctricas SAWO30 están disponibles en tres modelos: Circular, Esquinero y de pared.

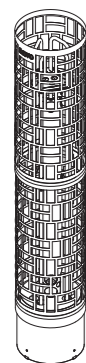

Round

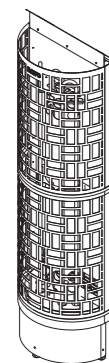

Wall

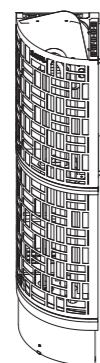

Corner



## SAWO30 Round

- » Rango de potencia: 4,5 – 24,0kW
- » Paneles de control disponibles: SAWO Sense, Saunova (Ni2), Innova (NS) y la versión con mandos de control incorporados (NB)
- » Carcasa: acero inoxidable o acero negro
- » Colocación de piedras más sencilla gracias a la separación en la parte central de la estufa
- » Túnel de aire desmontable: Calentamiento más rápido y calor más intenso o calentamiento más lento con vapor más suave
- » Patas ajustables
- » Opcional: protector de estufa y protección integrado



## SAWO30 Wall

- » Rango de potencia: 4,5 – 24,0kW
- » Paneles de control disponibles: SAWO Sense, Saunova (Ni2), Innova (NS) y la versión con mandos de control incorporados (NB)
- » Carcasa: acero inoxidable o acero negro
- » Colocación de piedras más sencilla gracias a la separación en la parte central de la estufa
- » Túnel de aire desmontable: Calentamiento más rápido y calor más intenso o calentamiento más lento con vapor más suave
- » Patas ajustables
- » Opcional: protector de estufa y protección integrado



## SAWO30 Corner

- » Rango de potencia: 4,5 – 12,0kW
- » Paneles de control disponibles: SAWO Sense, Saunova (Ni2), Innova (NS) y la versión con mandos de control incorporados (NB)
- » Carcasa: acero inoxidable o acero negro
- » Colocación de piedras más sencilla gracias a la separación en la parte central de la estufa
- » Túnel de aire desmontable: Calentamiento más rápido y calor más intenso o calentamiento más lento con vapor más suave
- » Patas ajustables
- » Opcional: protector de estufa y protección integrado

# SAWO30 Round

La SAWO30 Round es una estufa impresionante que puede colocarse perfectamente en el centro de la sauna o integrarse dentro de los bancos.

La gran cantidad de piedras en la estufa permite la creación de un ambiente personalizado con una combinación ideal de calor y humedad.



SAWO30 Round (Ni2)



SAWO30 Round Black (Ni2)



SAWO30 Round (NS)



SAWO30 Round Black (NS)



SAWO30 Round (NB)



SAWO30 Round Black (NB)

## Saunova (Ni2)

HEATER MODEL	kW	SAUNA ROOM		SIZE OF HEATER			STONES		CONTROL	MINIMUM SAFETY DISTANCES	
		MIN	MAX	LENGTH	WIDTH	HEIGHT	Without Stone Spacer	With Stone Spacer		A	B
SW3-45Ni2-P-C   SW3-45Ni2-BL-P-C	4,5	3	6	245	245	1305	70	60	Saunova	100	1900
SW3-60Ni2-P-C   SW3-60Ni2-BL-P-C	6,0	5	8	245	245	1305	70	60	Saunova	100	1900
SW6-90Ni2-P-C   SW6-90Ni2-BL-P-C	9,0	8	15	345	345	1305	160	100	Saunova	100	1900

## Saunova/Innova (NS)

HEATER MODEL	kW	SAUNA ROOM		SIZE OF HEATER			STONES		CONTROL	MINIMUM SAFETY DISTANCES	
		MIN	MAX	LENGTH	WIDTH	HEIGHT	Without Stone Spacer	With Stone Spacer		A	B
SW3-45NS-P-C   SW3-45NS-BL-P-C	4,5	3	6	245	245	1305	70	60	separate	100	1900
SW3-60NS-P-C   SW3-60NS-BL-P-C	6,0	5	8	245	245	1305	70	60	separate	100	1900
SW6-90NS-P-C   SW6-90NS-BL-P-C	9,0	8	15	345	345	1305	160	100	separate	100	1900
SW6-120NS-P   SW6-120NS-BL-P	12,0	11	18	345	345	1305	160	100	separate	100	2100
SW12-180NS-P   SW12-180NS-BL-P	18,0	18	30	515	515	1305	360	220	separate	100	2300
SW12-210NS-P   SW12-210NS-BL-P	21,0	22	35	515	515	1305	360	220	separate	100	2300
SW12-240NS-P   SW12-240NS-BL-P	24,0	24	40	515	515	1305	360	220	separate	100	2300

## Mandos integrados (NB)

HEATER MODEL	kW	SAUNA ROOM		SIZE OF HEATER			STONES		CONTROL	MINIMUM SAFETY DISTANCES	
		MIN	MAX	LENGTH	WIDTH	HEIGHT	Without Stone Spacer	With Stone Spacer		A	B
SW3-45NB-P-C   SW3-45NB-BL-P-C	4,5	3	6	245	245	1305	70	60	built-in (8+4h)	100	1900
SW3-60NB-P-C   SW3-60NB-BL-P-C	6,0	5	8	245	245	1305	70	60	built-in (8+4h)	100	1900
SW6-90NB-P-C   SW6-90NB-BL-P-C	9,0	8	15	345	345	1305	160	100	built-in (8+4h)	100	1900

## Accesorios para estufa (opcionales)

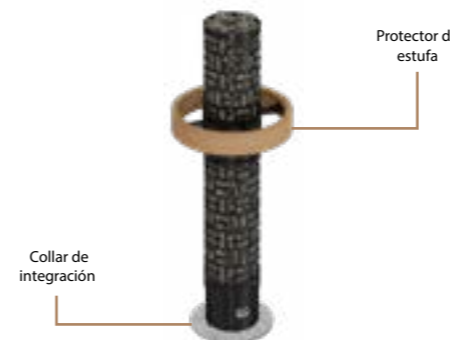

Protector de estufa

Collar de integración



Acero inoxidable



Madera Cedro (D) y Aspen (A)



Piedra de jabón

MODEL	SIZE OF COLLAR		
	LENGTH	WIDTH	HEIGHT
TH-COLLAR-ST2	460	460	45
TH-COLLAR-ST6	640	640	45
TH-COLLAR-ST12	820	820	45

MODEL	SIZE OF COLLAR		
	LENGTH	WIDTH	HEIGHT
TH-COLLAR-W2-D   A	440	440	45
TH-COLLAR-W6-D   A	540	540	45
TH-COLLAR-W12-D   A	685	685	45

MODEL	SIZE OF COLLAR		
	LENGTH	WIDTH	HEIGHT
TH-COLLAR-S2	510	510	45
TH-COLLAR-S6	620	620	45
TH-COLLAR-S12	790	790	45

## Protectores de estufa



Madera Cedro (D) y Aspen (A)

MODEL	SIZE OF GUARD RAIL			HEATERS
	LENGTH	WIDTH	HEIGHT	
SW-GUARD-W2-D   A	510	510	90	SW3
SW-GUARD-W6-D   A	620	620	90	SW6
SW-GUARD-W12-D   A	790	790	90	SW12

## Datos técnicos

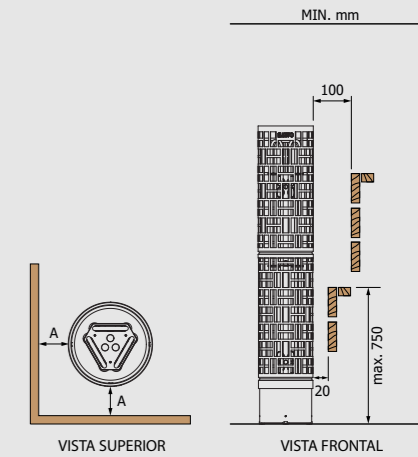

Distancias mínimas de seguridad

# SAWO30 Wall

La SAWO30 Wall es perfecta para ahorrar espacio sin renunciar al diseño de la sauna.

Una estufa alta y con estilo que lleva una gran carga de piedras, permitiendo generar un ambiente rico en vapor con una combinación ideal de calor y humedad.



SAWO30 Wall (Ni2)



SAWO30 Wall Black (Ni2)



SAWO30 Wall (NS)



SAWO30 Wall Black (NS)



SAWO30 Wall (NB)



SAWO30 Wall Black (NB)

## Saunova (Ni2)

HEATER MODEL	kW	SAUNA ROOM (m³)		SIZE OF HEATER (mm)			STONES (kg)		CONTROL	MINIMUM SAFETY DISTANCES (mm)	
		MIN	MAX	LENGTH	WIDTH	HEIGHT	Without Stone Spacer	With Stone Spacer		A	B
SW3-45Ni2-WL-P-C   SW3-45Ni2-WL-BL-P-C	4,5	3	6	*230	385	1395	70	60	Saunova	100	1900
SW3-60Ni2-WL-P-C   SW3-60Ni2-WL-BL-P-C	6,0	5	8	*230	385	1395	70	60	Saunova	100	1900
SW6-90Ni2-WL-P-C   SW6-90Ni2-WL-BL-P-C	9,0	8	15	*250	475	1395	160	100	Saunova	100	1900

## Saunova/Innova (NS)

HEATER MODEL	kW	SAUNA ROOM (m³)		SIZE OF HEATER (mm)			STONES (kg)		CONTROL	MINIMUM SAFETY DISTANCES (mm)	
		MIN	MAX	LENGTH	WIDTH	HEIGHT	Without Stone Spacer	With Stone Spacer		A	B
SW3-45NS-WL-P-C   SW3-45NS-WL-BL-P-C	4,5	3	6	*210	390	1375	70	60	separate	100	1900
SW3-60NS-WL-P-C   SW3-60NS-WL-BL-P-C	6,0	5	8	*210	390	1375	70	60	separate	100	1900
SW6-90NS-WL-P-C   SW6-90NS-WL-BL-P-C	9,0	8	15	*290	540	1375	160	100	separate	100	1900
SW6-120NS-WL-P   SW6-120NS-WL-BL-P	12,0	11	18	*290	540	1375	160	100	separate	100	2100
SW12-180NS-WL-P   SW12-180NS-WL-BL-P	18,0	18	30	*430	780	1375	250	165	separate	100	2300
SW12-210NS-WL-P   SW12-210NS-WL-BL-P	21,0	22	35	*430	780	1375	250	165	separate	100	2300
SW12-240NS-WL-P   SW12-240NS-WL-BL-P	24,0	24	40	*430	780	1375	250	165	separate	100	2300

\*Profundidad cuando se instala en la pared.

## Mandos integrados (NB)

HEATER MODEL	kW	SAUNA ROOM (m³)		SIZE OF HEATER (mm)			STONES (kg)		CONTROL	MINIMUM SAFETY DISTANCES (mm)	
		MIN	MAX	LENGTH	WIDTH	HEIGHT	Without Stone Spacer	With Stone Spacer		A	B
SW3-45NB-WL-P-C   SW3-45NB-WL-BL-P-C	4,5	3	6	*230	385	1395	70	60	built-in (8+4h)	100	1900
SW3-60NB-WL-P-C   SW3-60NB-WL-BL-P-C	6,0	5	8	*230	385	1395	70	60	built-in (8+4h)	100	1900
SW6-90NB-WL-P-C   SW6-90NB-WL-BL-P-C	9,0	8	15	*250	475	1395	160	100	built-in (8+4h)	100	1900

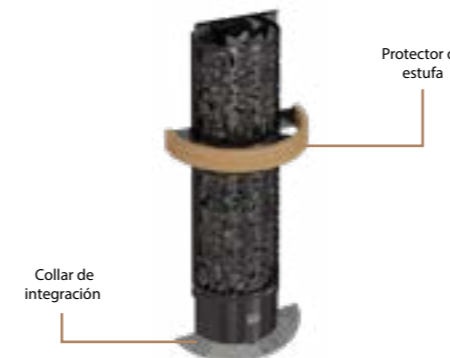

## Accesorios para estufa (opcionales)



MODEL	SIZE OF COLLAR (mm)	LENGTH	WIDTH	HEIGHT
TH-COLLAR-ST2-WL	355	650	45	
TH-COLLAR-ST6-WL	445	830	45	
TH-COLLAR-ST12-WL	535	1010	45	

MODEL	SIZE OF COLLAR (mm)	LENGTH	WIDTH	HEIGHT
TH-COLLAR-W2-WL-D   A	345	630	45	
TH-COLLAR-W6-WL-D   A	425	790	45	
TH-COLLAR-W12-WL-D   A	545	1030	45	

MODEL	SIZE OF COLLAR (mm)	LENGTH	WIDTH	HEIGHT
TH-COLLAR-S2-WL	345	635	45	
TH-COLLAR-S6-WL	425	795	45	
TH-COLLAR-S12-WL	545	1035	45	



MODEL	SIZE OF GUARD RAIL (mm)	LENGTH	WIDTH	HEIGHT
SW-GUARD-W2-WL-D   A	335	615	90	
SW-GUARD-W6-WL-D   A	410	795	90	

HEATERS
SW3
SW6
SW12

## Datos técnicos

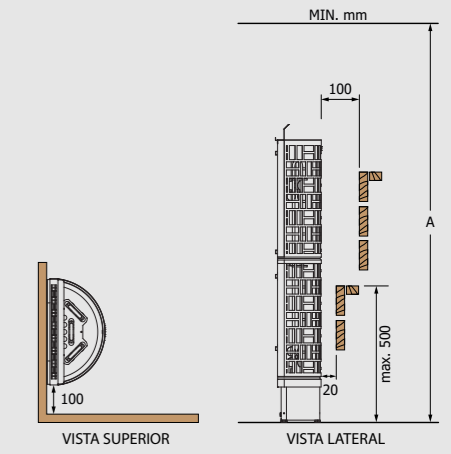

Distancias mínimas de seguridad

# SAWO30 Corner

La estufa SAWO30 Corner se instala en la esquina de la sauna, ofreciendo la misma presencia estética de la serie SAWO30 pero optimizando el espacio dentro de la cabina.

Gracias a su altura y a su alta capacidad de piedras, la estufa permite la creación de un ambiente personalizado con una combinación ideal de calor y humedad.

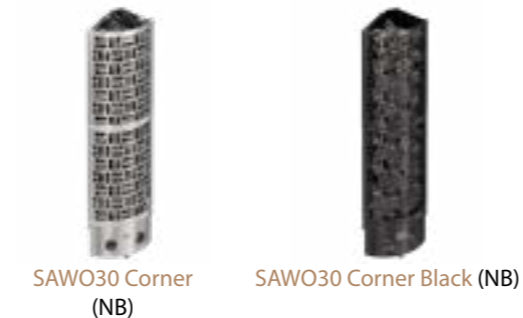

## Saunova (Ni2)

HEATER MODEL	kW	SAUNA ROOM		SIZE OF HEATER			STONES		CONTROL	MINIMUM SAFETY DISTANCES	
		MIN (m³)	MAX (m³)	LENGTH (mm)	WIDTH (mm)	HEIGHT (mm)	Without Stone Spacer (kg)	With Stone Spacer (kg)		A	B
SW3-45Ni2-CNR-P-C   SW3-45Ni2-CNR-BL-P-C	4,5	3	6	*300	300	1380	70	45	Saunova	100	1900
SW3-60Ni2-CNR-P-C   SW3-60Ni2-CNR-BL-P-C	6,0	5	8	*300	300	1380	70	45	Saunova	100	1900
SW6-90Ni2-CNR-P-C   SW6-90Ni2-CNR-BL-P-C	9,0	8	15	*415	415	1380	105	80	Saunova	100	1900

## Saunova/Innova (NS)

HEATER MODEL	kW	SAUNA ROOM		SIZE OF HEATER			STONES		CONTROL	MINIMUM SAFETY DISTANCES	
		MIN (m³)	MAX (m³)	LENGTH (mm)	WIDTH (mm)	HEIGHT (mm)	Without Stone Spacer (kg)	With Stone Spacer (kg)		A	B
SW3-45NS-CNR-P-C   SW3-45NS-CNR-BL-P-C	4,5	3	6	*300	300	1380	70	45	separate	100	1900
SW3-60NS-CNR-P-C   SW3-60NS-CNR-BL-P-C	6,0	5	8	*300	300	1380	70	45	separate	100	1900
SW6-90NS-CNR-P-C   SW6-90NS-CNR-BL-P-C	9,0	8	15	*415	415	1380	105	80	separate	100	1900
SW6-120NS-CNR-P   SW6-120NS-CNR-BL-P	12,0	11	18	*415	415	1380	105	80	separate	100	2100

## Mandos integrados (NB)

HEATER MODEL	kW	SAUNA ROOM		SIZE OF HEATER			STONES		CONTROL	MINIMUM SAFETY DISTANCES	
		MIN (m³)	MAX (m³)	LENGTH (mm)	WIDTH (mm)	HEIGHT (mm)	Without Stone Spacer (kg)	With Stone Spacer (kg)		A	B
SW3-45NB-CNR-P-C   SW3-45NB-CNR-BL-P-C	4,5	3	6	*300	300	1380	70	45	built-in (8+4h)	100	1900
SW3-60NB-CNR-P-C   SW3-60NB-CNR-BL-P-C	6,0	5	8	*300	300	1380	70	45	built-in (8+4h)	100	1900
SW6-90NB-CNR-P-C   SW6-90NB-CNR-BL-P-C	9,0	8	15	*415	415	1380	105	80	built-in (8+4h)	100	1900

\*Profundidad cuando se instala en la pared.

## Accesorios para estufa (opcionales)

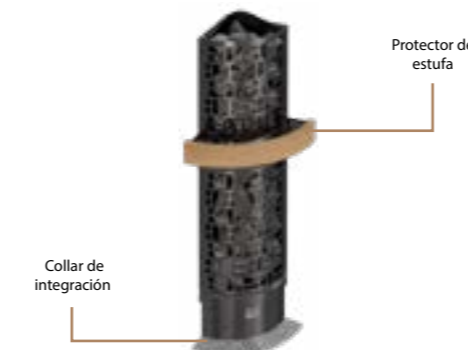

MODEL	SIZE OF COLLAR
	LENGTH (mm) WIDTH (mm) HEIGHT (mm)
TH-COLLAR-ST2-CNR	220 670 45
TH-COLLAR-ST6-CNR	245 795 45

MODEL	SIZE OF COLLAR
	LENGTH (mm) WIDTH (mm) HEIGHT (mm)
TH-COLLAR-W2-CNR-D   A	200 600 45
TH-COLLAR-W6-CNR-D   A	235 755 45

MODEL	SIZE OF COLLAR
	LENGTH (mm) WIDTH (mm) HEIGHT (mm)
TH-COLLAR-S2-CNR	425 425 45
TH-COLLAR-S6-CNR	535 535 45



MODEL	SIZE OF GUARD RAIL
	LENGTH (mm) WIDTH (mm) HEIGHT (mm)
SW-GUARD-W2-CNR-D   A	210 580 90
SW-GUARD-W6-CNR-D   A	245 755 90

HEATERS
SW3
SW6

## Datos técnicos

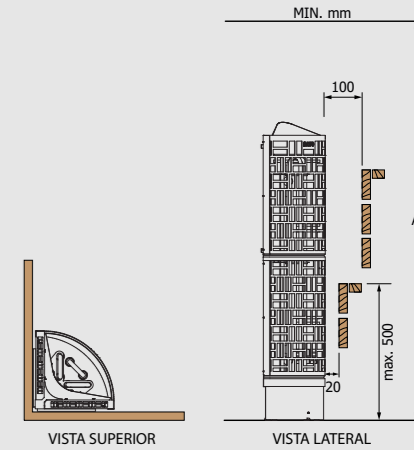

Distancias mínimas de seguridad

## Modelo Tower

Las estufas modelo Tower están diseñadas para producir vapor desde la parte más baja hasta la más alta en la sauna, similar a una sauna de humo. Incorporan un túnel de aire extraíble que separa las piedras y permite alcanzar temperaturas más altas y al mismo tiempo ahorrar energía al reducir el tiempo de calentamiento, mejora el flujo de aire y prolonga la vida útil de las resistencias al evitar el contacto directo con las piedras.

Sin Túnel de aire, el *löyly* es más suave.

La gama del modelo Tower incluye modelos Round, Wall y Corner.

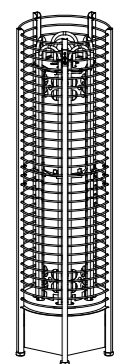

Round

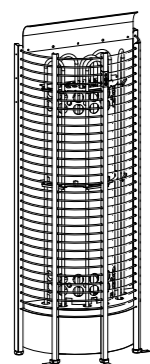

Wall

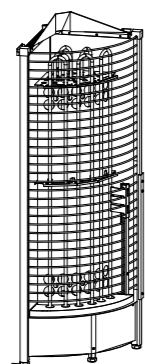

Corner



### Tower ROUND

- » Rango de potencia: 3,0 – 24,0kW
- » Paneles de control disponibles: SAWO Sense, Saunova (Ni2), Innova (NS) y la versión con mandos de control incorporados (NB)
- » Carcasa: Acero inoxidable
- » Moving steel rings for replacement of broken stones
- » Túnel de aire desmontable: Calentamiento más rápido y calor más intenso o calentamiento más lento con vapor más suave
- » Patas ajustables
- » Protector de estufa y collar de integración opcional



### Tower WALL

- » Rango de potencia: 3,0 – 24,0kW
- » Paneles de control disponibles: SAWO Sense, Saunova (Ni2), Innova (NS) y la versión con mandos de control incorporados (NB)
- » Carcasa: Acero inoxidable
- » Moving rings for replacement of broken stones
- » Túnel de aire desmontable: Calentamiento más rápido y calor más intenso o calentamiento más lento con vapor más suave
- » Patas ajustables
- » Protector de estufa y collar de integración opcional



### Tower CORNER

- » Rango de potencia: 3,0 – 12,0kW
- » Paneles de control disponibles: SAWO Sense, Saunova (Ni2), Innova (NS) y la versión con mandos de control incorporados (NB)
- » Carcasa: Acero inoxidable
- » Moving upper part for replacement of broken stones
- » Túnel de aire desmontable: Calentamiento más rápido y calor más intenso o calentamiento más lento con vapor más suave
- » Patas ajustables
- » Protector de estufa y collar de integración opcional

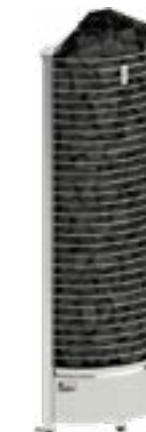

# Tower Round

Tower Round es una estufa de elegancia atemporal que ofrece un calor suave, constante y húmedo de larga duración.

Puede colocarse perfectamente en el centro de la sauna o integrarse en los bancos.



## Saunova (Ni2) and Innova (Ni)

HEATER MODEL	kW	SAUNA ROOM		SIZE OF HEATER			STONES		CONTROL	MINIMUM SAFETY DISTANCES	
		MIN	MAX	LENGTH	WIDTH	HEIGHT	Without Stone Spacer	With Stone Spacer		A	B
TH2-30Ni2-P-C	3,0	2	4	260	260	1300	70	60	Saunova	100	1900
TH3-35Ni2-P-C	3,5	3	6	260	260	1300	70	60	Saunova	100	1900
TH3-45Ni2-P-C	4,5	3	6	260	260	1300	70	60	Saunova	100	1900
TH3-60Ni2-P-C	6,0	5	8	260	260	1300	70	60	Saunova	150	1900
TH4-60Ni2-P-C	6,0	5	9	315	315	1300	105	90	Saunova	150	1900
TH5-80Ni2-P-C	8,0	8	14	315	315	1300	105	90	Saunova	150	1900
TH5-90Ni2-P-C	9,0	8	14	315	315	1300	105	90	Saunova	150	1900
TH6-80Ni2-P-C	8,0	7	14	365	365	1300	160	100	Saunova	150	1900
TH6-90Ni2-P-C	9,0	8	15	365	365	1300	160	100	Saunova	150	1900
TH6-105Ni-P	10,5	9	16	365	365	1300	160	100	Innova	150	1900
TH6-120Ni-P	12,0	11	18	365	365	1300	160	100	Innova	200	2100
TH9-105Ni-P	10,5	10	16	450	450	1300	230	165	Innova	150	2100
TH9-120Ni-P	12,0	11	20	450	450	1300	230	165	Innova	150	2100
TH9-150Ni-P	15,0	14	25	450	450	1300	230	165	Innova	200	2100
TH12-150Ni-P	15,0	15	26	545	545	1300	360	220	Innova	200	2300
TH12-180Ni-P	18,0	18	30	545	545	1300	360	220	Innova	200	2300
TH12-210Ni-P	21,0	22	35	545	545	1300	360	220	Innova	200	2300
TH12-240Ni-P	24,0	24	40	545	545	1300	360	220	Innova	200	2300

## Mandos integrados (NB) and Saunova/Innova

HEATER MODEL	kW	SAUNA ROOM		SIZE OF HEATER			STONES		CONTROL	MINIMUM SAFETY DISTANCES			
		MIN	MAX	LENGTH	WIDTH	HEIGHT	Without Stone Spacer	With Stone Spacer		A	B		
TH2-30NB-P   NS-P	3,0	2	4	260	260	1300	70	60	separate	100	150	1900	
TH3-35NB-P-C   NS-P-C	3,5	3	6	260	260	1300	70	60	built-in (8+4h)	separate	150	100	1900
TH3-45NB-P-C   NS-P-C	4,5	3	6	260	260	1300	70	60	built-in (8+4h)	separate	150	100	1900
TH3-60NB-P-C   NS-P-C	6,0	5	8	260	260	1300	70	60	built-in (8+4h)	separate	150	150	1900
TH4-60NB-P-C   NS-P-C	6,0	5	9	315	315	1300	105	90	built-in (8+4h)	separate	150	150	1900
TH5-80NB-P-C   NS-P-C	8,0	7	13	315	315	1300	105	90	built-in (8+4h)	separate	100	100	1900
TH5-90NS-P-C	9,0	8	14	315	315	1300	105	90	separate	separate	150	1900	
TH6-80NB-P-C   NS-P-C	8,0	7	14	365	365	1300	160	100	built-in (8+4h)	separate	100	100	1900
TH6-90NB-P-C   NS-P-C	9,0	8	15	365	365	1300	160	100	built-in (8+4h)	separate	100	100	1900
TH6-105NS-P	10,5	9	16	365	365	1300	160	100	separate	separate	150	1900	
TH6-120NS-P	12,0	11	18	365	365	1300	160	100	separate	separate	200	2100	
TH9-105NS-P	10,5	10	16	450	450	1300	230	165	separate	separate	150	2100	
TH9-120NS-P	12,0	11	20	450	450	1300	230	165	separate	separate	150	2100	
TH9-150NS-P	15,0	14	25	450	450	1300	230	165	separate	separate	200	2100	
TH9-180NS-P	18,0	18	28	450	450	1300	230	165	separate	separate	200	2100	
TH12-150NS-P	15,0	15	26	545	545	1300	360	220	separate	separate	200	2300	
TH12-180NS-P	18,0	18	30	545	545	1300	360	220	separate	separate	200	2300	
TH12-210NS-P	21,0	22	35	545	545	1300	360	220	separate	separate	200	2300	
TH12-240NS-P	24,0	24	40	545	545	1300	360	220	separate	separate	200	2300	

## Accesorios para estufa (opcionales)



MODEL	SIZE OF COLLAR		
	LENGTH	WIDTH	HEIGHT
TH-COLLAR-V2-ST4	420	420	105



MODEL	SIZE OF COLLAR		
	LENGTH	WIDTH	HEIGHT
TH-COLLAR-ST2	460	460	45
TH-COLLAR-ST4	540	540	45
TH-COLLAR-ST6	640	640	45
TH-COLLAR-ST9	720	720	45
TH-COLLAR-ST12	820	820	45



MODEL	SIZE OF COLLAR		
	LENGTH	WIDTH	HEIGHT
TH-COLLAR-W2-D   A	440	440	45
TH-COLLAR-W4-D   A	485	485	45
TH-COLLAR-W6-D   A	540	540	45
TH-COLLAR-W9-D   A	560	560	45
TH-COLLAR-W12-D   A	685	685	45



MODEL	SIZE OF COLLAR		
	LENGTH	WIDTH	HEIGHT
TH-COLLAR-S2	507	507	45
TH-COLLAR-S4	560	560	45
TH-COLLAR-S6	620	620	45
TH-COLLAR-S9	690	690	45
TH-COLLAR-S12	790	790	45



MODEL	SIZE OF GUARD RAIL			MODEL
	LENGTH	WIDTH	HEIGHT	
TH-GUARD-W2-D   A	510	510	45	TH2   TH3
TH-GUARD-W4-D   A	560	560	45	TH4   TH5
TH-GUARD-W6-D   A	620	620	45	TH6
TH-GUARD-W9-D   A	690	690	45	TH9
TH-GUARD-W12-D   A	790	790	45	TH12

## Datos técnicos

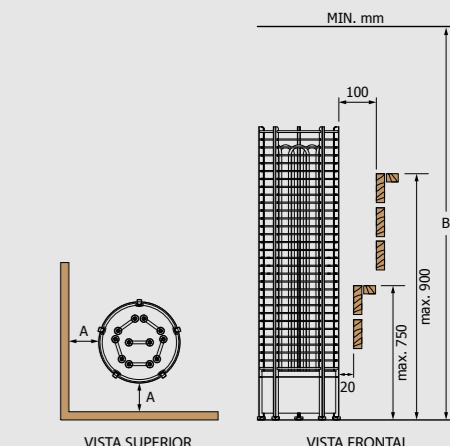

Distancias mínimas de seguridad

# Tower Wall

La estufa, modelo Tower Wall es una estufa de elegancia atemporal que proporciona un calor suave, constante y húmedo. Es una excelente solución para ahorrar espacio sin renunciar al impacto visual en la sauna.

Tiene la posibilidad de instalar dos estufas Tower Wall de 24,0 kW en línea y obtener así hasta 48,0 kW de potencia con un único conjunto.



Tower Wall (Ni2)

Tower Wall (Ni)



Tower Wall (NB)

Tower Wall (NS)

## Saunova (Ni2) and Innova (Ni)

HEATER MODEL	kW	SAUNA ROOM		SIZE OF HEATER			STONES		CONTROL	MINIMUM SAFETY DISTANCES	
		MIN (m²)	MAX (m²)	LENGTH (mm)	WIDTH (mm)	HEIGHT (mm)	Without Stone Spacer (kg)	With Stone Spacer (kg)		A	B
TH2-30Ni2-WL-P-C	3,0	2	4	*230	385	1395	70	60	Saunova	100	1900
TH3-35Ni2-WL-P-C	3,5	3	6	*230	385	1395	70	60	Saunova	100	1900
TH3-45Ni2-WL-P-C	4,5	3	6	*230	385	1395	70	60	Saunova	100	1900
TH3-60Ni2-WL-P-C	6,0	5	8	*230	385	1395	70	60	Saunova	100	1900
TH4-60Ni2-WL-P-C	6,0	5	9	*250	475	1395	105	90	Saunova	100	1900
TH5-80Ni2-WL-P-C	8,0	8	14	*250	475	1395	105	90	Saunova	100	1900
TH5-90Ni2-WL-P-C	9,0	8	14	*250	475	1395	105	90	Saunova	100	1900
TH6-80Ni2-WL-P-C	8,0	7	14	*320	550	1395	160	100	Saunova	100	1900
TH6-90Ni2-WL-P-C	9,0	8	15	*320	550	1395	160	100	Saunova	100	1900
TH6-105Ni-WL-P	10,5	9	16	*320	550	1395	160	100	Innova	100	1900
TH6-120Ni-WL-P	12,0	11	18	*320	550	1395	160	100	Innova	100	2100
TH9-105Ni-WL-P	10,5	10	16	*355	650	1395	230	165	Innova	100	2100
TH9-120Ni-WL-P	12,0	11	20	*355	650	1395	230	165	Innova	100	2100
TH9-150Ni-WL-P	15,0	14	25	*355	650	1395	230	165	Innova	100	2100
TH12-150Ni-WL-P	15,0	15	26	*425	790	1395	360	220	Innova	100	2300
TH12-180Ni-WL-P	18,0	18	30	*425	790	1395	360	220	Innova	100	2300
TH12-210Ni-WL-P	21,0	22	35	*425	790	1395	360	220	Innova	100	2300
TH12-240Ni-WL-P	24,0	24	40	*425	790	1395	360	220	Innova	100	2300

## Mandos integrados (NB) and Saunova/Innova (NS)

HEATER MODEL	kW	SAUNA ROOM		SIZE OF HEATER			STONES		CONTROL	MINIMUM SAFETY DISTANCES	
		MIN (m²)	MAX (m²)	LENGTH (mm)	WIDTH (mm)	HEIGHT (mm)	Without Stone Spacer (kg)	With Stone Spacer (kg)		A	B
TH2-30-NS-WL-P	3,0	2	4	*230	385	1395	70	60	built-in (8+4h)   separate	100	1900
TH3-35-NB NS-WL-P-C	3,5	3	6	*230	385	1395	70	60	built-in (8+4h)   separate	100	1900
TH3-45-NB NS-WL-P-C	4,5	3	6	*230	385	1395	70	60	built-in (8+4h)   separate	100	1900
TH3-60-NB NS-WL-P-C	6,0	5	8	*230	385	1395	70	60	built-in (8+4h)   separate	100	1900
TH4-60-NB NS-WL-P-C	6,0	5	9	*250	475	1395	105	90	built-in (8+4h)   separate	100	1900
TH5-80-NB NS-WL-P-C	8,0	7	13	*250	475	1395	105	90	built-in (8+4h)   separate	100	1900
TH5-90NS-WL-P-C	9,0	8	14	*250	475	1395	105	90	separate	100	1900
TH6-80-NB NS-WL-P-C	8,0	7	14	*300	540	1395	160	100	built-in (8+4h)   separate	100	1900
TH6-90-NB NS-WL-P-C	9,0	8	15	*300	540	1395	160	100	built-in (8+4h)   separate	100	1900
TH6-105NS-WL-P	10,5	9	16	*300	540	1395	160	100	separate	100	2100
TH6-120NS-WL-P	12,0	11	18	*300	540	1395	160	100	separate	100	2100
TH9-105NS-WL-P	10,5	10	16	*355	650	1395	230	165	separate	100	2100
TH9-120NS-WL-P	12,0	11	20	*355	650	1395	230	165	separate	100	2100
TH9-150NS-WL-P	15,0	14	25	*355	650	1395	230	165	separate	100	2100
TH9-180NS-WL-P	18,0	18	28	*355	650	1395	230	165	separate	100	2300
TH12-150NS-WL-P	15,0	15	26	*425	790	1395	360	220	separate	100	2300
TH12-180NS-WL-P	18,0	18	30	*425	790	1395	360	220	separate	100	2300
TH12-210NS-WL-P	21,0	22	35	*425	790	1395	360	220	separate	100	2300
TH12-240NS-WL-P	24,0	24	40	*425	790	1395	360	220	separate	100	2300

\*Profundidad cuando se instala en la pared.

## Datos técnicos

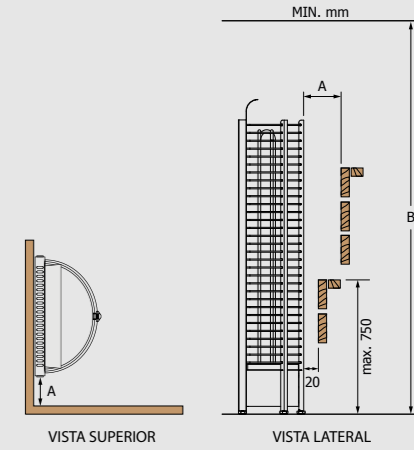

Distancias mínimas de seguridad

## Accesorios para estufa (opcionales)

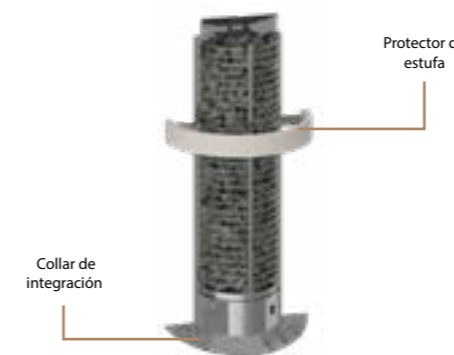

Collar de integración

Protector de estufa

Collares de integración			Protectores de estufa									
Acero inoxidable			Madera									
Cedro (D) y Aspen (A)			Cedro (D) y Aspen (A)									
MODEL	SIZE OF COLLAR LENGTH (mm)	WIDTH (mm)	HEIGHT (mm)	MODEL	SIZE OF GUARD RAIL LENGTH (mm)	WIDTH (mm)	HEIGHT (mm)	MODEL				
TH-COLLAR-ST2-WL	355	650	45	TH-COLLAR-W2-WL-D   A	345	630	45	TH-GUARD-W2-WL-D   A	355	645	90	TH2   TH3
TH-COLLAR-ST4-WL	380	700	45	TH-COLLAR-W4-WL-D   A	385	715	45	TH-GUARD-W4-WL-D   A	725	395	90	
TH-COLLAR-ST6-WL	445	830	45	TH-COLLAR-W6-WL-D   A	425	790	45	TH-GUARD-W6-WL-D   A	435	800	90	TH6
TH-COLLAR-ST9-WL	470	880	45	TH-COLLAR-W9-WL-D   A	480	890	45	TH-GUARD-W9-WL-D   A	485	900	90	
TH-COLLAR-ST12-WL	535	1010	45	TH-COLLAR-W12-WL-D   A	545	1030	45	TH-GUARD-W12-WL-D   A	555	1040	90	TH9
												TH12

# Tower Corner

La estufa Tower Corner está diseñada específicamente para la instalación en la esquina de la sauna y aprovechar al máximo la distribución de la cabina sin sacrificar estilo ni rendimiento. Asegura un calor suave y envolvente para una experiencia de relajación plena.



Tower Corner (Ni2)

Tower Corner (Ni)



Tower Corner (NB)

Tower Corner (NS)

## Saunova (Ni2) and Innova (Ni)

HEATER MODEL	kW	SAUNA ROOM		SIZE OF HEATER			STONES		CONTROL	MINIMUM SAFETY DISTANCES	
		MIN	MAX	LENGTH	WIDTH	HEIGHT	Without Stone Spacer	With Stone Spacer		A	B
TH2-30Ni2-CNR-P-C	3,0	2	4	300	*300	1380	70	45	Saunova	100	1900
TH3-35Ni2-CNR-P-C	3,5	3	6	300	*300	1380	70	45	Saunova	100	1900
TH3-45Ni2-CNR-P-C	4,5	3	6	300	*300	1380	70	45	Saunova	100	1900
TH3-60Ni2-CNR-P-C	6,0	5	8	300	*300	1380	70	45	Saunova	100	1900
TH4-60Ni2-CNR-P-C	6,0	5	9	355	*355	1380	105	70	Saunova	100	1900
TH5-80Ni2-CNR-P-C	8,0	7	13	355	*355	1380	105	70	Saunova	100	1900
TH5-90Ni2-CNR-P-C	9,0	8	14	355	*355	1380	105	70	Saunova	100	1900
TH6-80Ni2-CNR-P	8,0	7	14	415	*415	1380	160	80	Saunova	100	1900
TH6-90Ni2-CNR-P	9,0	8	15	415	*415	1380	160	80	Saunova	100	1900
TH6-105Ni2-CNR-P	10,5	9	16	415	*415	1380	160	100	Innova	100	1900
TH6-120Ni2-CNR-P	12,0	11	18	415	*415	1380	160	100	Innova	100	2100

## Mandos integrados (NB)

HEATER MODEL	kW	SAUNA ROOM		SIZE OF HEATER			STONES		CONTROL	MINIMUM SAFETY DISTANCES	
		MIN	MAX	LENGTH	WIDTH	HEIGHT	Without Stone Spacer	With Stone Spacer		A	B
TH2-30NB-CNR-P-C	3,0	2	4	300	*300	1380	70	45	built-in (8+4h)	125	1900
TH3-35NB-CNR-P-C	3,5	3	6	300	*300	1380	70	45	built-in (8+4h)	125	1900
TH3-45NB-CNR-P-C	4,5	3	6	300	*300	1380	70	45	built-in (8+4h)	125	1900
TH3-60NB-CNR-P-C	6,0	5	8	300	*300	1380	70	45	built-in (8+4h)	125	1900
TH4-60NB-CNR-P-C	6,0	5	9	355	*355	1380	105	70	built-in (8+4h)	125	1900
TH5-80NB-CNR-P-C	8,0	7	13	355	*355	1380	105	70	built-in (8+4h)	125	1900
TH5-90NB-CNR-P-C	8,0	7	14	415	*415	1380	160	80	built-in (8+4h)	125	1900
TH6-80NB-CNR-P-C	8,0	7	14	415	*415	1380	160	80	built-in (8+4h)	125	1900
TH6-90NB-CNR-P-C	9,0	8	15	415	*415	1380	160	80	built-in (8+4h)	125	1900

## Saunova/Innova (NS)

HEATER MODEL	kW	SAUNA ROOM		SIZE OF HEATER			STONES		CONTROL	MINIMUM SAFETY DISTANCES	
		MIN	MAX	LENGTH	WIDTH	HEIGHT	Without Stone Spacer	With Stone Spacer		A	B
TH3-35NS-CNR-P-C	3,5	3	6	300	*300	1380	70	45	separate	100	1900
TH3-45NS-CNR-P-C	4,5	3	6	300	*300	1380	70	45	separate	100	1900
TH3-60NS-CNR-P-C	6,0	5	8	300	*300	1380	70	45	separate	100	1900
TH4-60NS-CNR-P-C	6,0	5	9	355	*355	1380	105	70	separate	100	1900
TH5-80NS-CNR-P-C	8,0	7	13	355	*355	1380	105	70	separate	100	1900
TH5-90NS-CNR-P-C	8,0	8	14	355	*355	1380	105	70	separate	100	1900
TH6-80NS-CNR-P-C	8,0	7	14	415	*415	1380	160	80	separate	100	1900
TH6-90NS-CNR-P-C	9,0	8	15	415	*415	1380	160	80	separate	100	1900
TH6-105NS-CNR-P	10,5	9	16	415	*415	1380	160	80	separate	100	1900
TH6-120NS-CNR-P	12,0	11	18	415	*415	1380	160	80	separate	100	2100

\*Profundidad cuando se instala en la pared.

## Datos técnicos

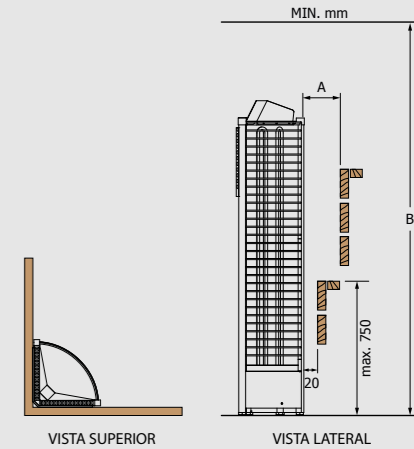

Distancias mínimas de seguridad

## Accesorios para estufa (opcionales)

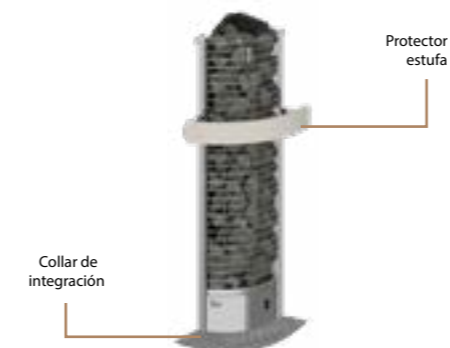

Protector de estufa

Collar de integración



Acero inoxidable

Collares de integración

Madera Cedro (D) y Aspen (A)

Piedra de jabón



Protectores de estufa

Madera Cedro (D) y Aspen (A)

MODEL	SIZE OF COLLAR		
	LENGTH	WIDTH	HEIGHT
TH-COLLAR-ST2-CNR	220	670	45
TH-COLLAR-ST4-CNR	235	730	45
TH-COLLAR-ST6-CNR	245	795	45

MODEL	SIZE OF COLLAR		
	LENGTH	WIDTH	HEIGHT
TH-COLLAR-W2-CNR-D   A	200	600	45
TH-COLLAR-W4-CNR-D   A	215	670	45
TH-COLLAR-W6-CNR-D   A	235	755	45

MODEL	SIZE OF COLLAR		
	LENGTH	WIDTH	HEIGHT
TH-COLLAR-S2-CNR	425	425	45
TH-COLLAR-S4-CNR	475	475	45
TH-COLLAR-S6-CNR	535	535	45

MODEL	SIZE OF GUARD RAIL		
	LENGTH	WIDTH	HEIGHT
TH-GUARD-W2-CNR-D A	240	595	90
TH-GUARD-W4-CNR-D A	255	670	90
TH-GUARD-W6-CNR-D A	270	755	90

MODEL
TH2   TH3
TH4   TH5
TH6

## Modelo Aries

Las estufas Aries están diseñadas con una estructura abierta y adaptada a las necesidades de las estufas actuales.

La gama Aries ofrece un rendimiento térmico más intenso gracias a su diseño elevado y gran cantidad de piedras..

Las estufas Aries están disponibles en modelos Round, Wall y Corner.

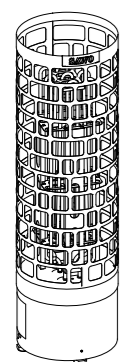

Round

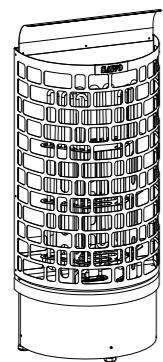

Wall



Corner



### Aries ROUND

- » Rango de potencia: 4,5 – 18,0kW
- » Paneles de control disponibles: SAWO Sense, Saunova (Ni2), Innova (NS) y la versión con mandos de control incorporados (NB)
- » Túnel de aire integrado
- » Carcasa: acero inoxidable o acero negro
- » Patas ajustables
- » Opcional: protector de estufa y collar de integración



### Aries WALL

- » Rango de potencia: 4,5 – 9,0kW
- » Paneles de control disponibles: SAWO Sense, Saunova (Ni2), Innova (NS) y la versión con mandos de control incorporados (NB)
- » Túnel de aire integrado
- » Carcasa: acero inoxidable o acero negro
- » Patas ajustables
- » Opcional: protector de estufa y collar de integración



### Aries CORNER

- » Rango de potencia: 4,5 – 9,0kW
- » Paneles de control disponibles: SAWO Sense, Saunova (Ni2), Innova (NS) y la versión con mandos de control incorporados (NB)
- » Túnel de aire integrado
- » Carcasa: acero inoxidable o acero negro
- » Patas ajustables
- » Opcional: protector de estufa y collar de integración

# Aries Round

Round es una estufa de diseño elegante que proporciona un calor equilibrado y uniforme desde la parte superior hasta la inferior de la cabina. Puede instalar la estufa en el centro de la sauna o integrar en los bancos.



Aries Round (Ni2)



Aries Round Black (Ni2)



Aries Round (NS)



Aries Round Black (NS)



Aries Round (NB)



Aries Round Black (NB)

## Saunova (Ni2)

HEATER MODEL	kW	SAUNA ROOM (m <sup>2</sup> )		SIZE OF HEATER (mm)			STONES (kg)	CONTROL	MINIMUM SAFETY DISTANCES (mm)	
		MIN	MAX	LENGTH	WIDTH	HEIGHT			A	B
ARI3-45Ni2-P-C   ARI3-45Ni2-BL-P-C	4,5	3	6	300	300	930	60	Saunova	100	1900
ARI3-60Ni2-P-C   ARI3-60Ni2-BL-P-C	6,0	5	9	300	300	930	60	Saunova	100	1900
ARI3-75Ni2-P-C   ARI3-75Ni2-BL-P-C	7,5	7	12	300	300	930	60	Saunova	100	1900
ARI3-90Ni2-P-C   ARI3-90Ni2-BL-P-C	9,0	8	13	300	300	930	60	Saunova	100	1900

## Saunova/Innova (NS)

HEATER MODEL	kW	SAUNA ROOM (m <sup>2</sup> )		SIZE OF HEATER (mm)			STONES (kg)	CONTROL	MINIMUM SAFETY DISTANCES (mm)	
		MIN	MAX	LENGTH	WIDTH	HEIGHT			A	B
ARI3-45NS-P-C   ARI3-45NS-BL-P-C	4,5	3	6	300	300	930	60	separate	100	1900
ARI3-60NS-P-C   ARI3-60NS-BL-P-C	6,0	5	9	300	300	930	60	separate	100	1900
ARI3-75NS-P-C   ARI3-75NS-BL-P-C	7,5	7	12	300	300	930	60	separate	100	1900
ARI3-90NS-P-C   ARI3-90NS-BL-P-C	9,0	8	14	300	300	930	60	separate	100	1900
ARI6-90NS-P   ARI6-90NS-BL-P-C	9,0	8	14	440	440	930	110	separate	100	1900
ARI6-105NS-P   ARI6-105NS-BL-P-C	10,5	9	15	440	440	930	110	separate	100	1900
ARI6-120NS-P   ARI6-120NS-BL-P-C	12,0	10	18	440	440	930	110	separate	100	2100
ARI6-150NS-P   ARI6-150NS-BL-P-C	15,0	13	23	440	440	930	110	separate	100	2100
ARI6-180NS-P   ARI6-180NS-BL-P-C	18,0	15	26	440	440	930	110	separate	125	2100

## Mandos integrados (NB)

HEATER MODEL	kW	SAUNA ROOM (m <sup>2</sup> )		SIZE OF HEATER (mm)			STONES (kg)	CONTROL	MINIMUM SAFETY DISTANCES (mm)	
		MIN	MAX	LENGTH	WIDTH	HEIGHT			A	B
ARI3-45NB-P-C   ARI3-45NB-BL-P-C	4,5	3	6	300	300	930	60	built-in (8+4h)	100	1900
ARI3-60NB-P-C   ARI3-60NB-BL-P-C	6,0	5	9	300	300	930	60	built-in (8+4h)	100	1900
ARI3-75NB-P-C   ARI3-75NB-BL-P-C	7,5	7	12	300	300	930	60	built-in (8+4h)	100	1900
ARI3-90NB-P-C   ARI3-90NB-BL-P-C	9,0	8	14	300	300	930	60	built-in (8+4h)	100	1900
ARI6-90NB-P-C   ARI6-90NB-BL-P-C	9,0	8	14	440	440	930	110	built-in (8+4h)	100	1900

## Datos técnicos

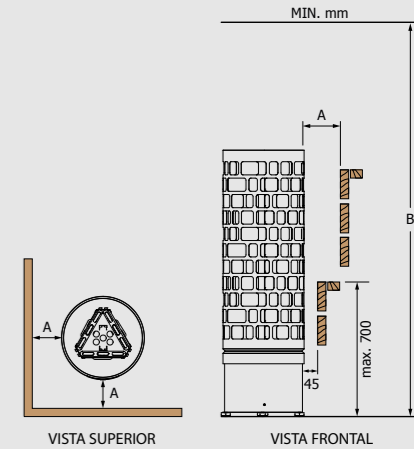

Distancias mínimas de seguridad

## Accesorios para estufa (opcionales)



Acero inoxidable (for ARI3)

MODEL	SIZE OF COLLAR (mm)	LENGTH	WIDTH	HEIGHT
TH-COLLAR-V2-ST4	420	420	105	



Acero inoxidable

MODEL	SIZE OF COLLAR (mm)	LENGTH	WIDTH	HEIGHT
TH-COLLAR-ST4	540	540	45	
TH-COLLAR-ST6	640	640	45	



Madera Cedro (D) y Aspen (A)

MODEL	SIZE OF COLLAR (mm)	LENGTH	WIDTH	HEIGHT
TH-COLLAR-W4-D   A	485	485	45	
TH-COLLAR-W6-D   A	540	540	45	



Piedra de jabón

MODEL	SIZE OF COLLAR (mm)	LENGTH	WIDTH	HEIGHT
TH-COLLAR-S4	560	560	45	
TH-COLLAR-S6	620	620	45	



Madera Cedro (D) y Aspen (A)

MODEL	SIZE OF GUARD RAIL (mm)	WIDTH	DEPTH	HEIGHT
ARI-GUARD-W3-D   A	570	570	110	
ARI-GUARD-W6-D   A	700	700	110	

MODEL
ARI3
ARI6

# Aries Wall

Aries Wall es una estufa que ocupa poco espacio en la sauna y combina practicidad y elegancia con su diseño estilizado.

Es ideal para instalación en pared y proporciona un calor equilibrado y uniforme.



Aries Wall (Ni2)



Aries Wall Black (Ni2)



Aries Wall (NS)



Aries Wall Black (NS)



Aries Wall (NB)



Aries Wall Black (NB)



## Saunova (Ni2)

HEATER MODEL	kW	SAUNA ROOM (m²)		SIZE OF HEATER (mm)			STONES (kg)	CONTROL	MINIMUM SAFETY DISTANCES	
		MIN	MAX	LENGTH	WIDTH	HEIGHT			A	B
ARI3-45NI2-WL-P-C   ARI3-45NI2-WL-BL-P-C	4,5	3	6	*250	415	1030	65	Saunova	100	1900
ARI3-60NI2-WL-P-C   ARI3-60NI2-WL-BL-P-C	6,0	5	9	*250	415	1030	65	Saunova	100	1900
ARI3-75NI2-WL-P-C   ARI3-75NI2-WL-BL-P-C	7,5	7	13	*250	415	1030	65	Saunova	100	1900
ARI3-90NI2-WL-P-C   ARI3-90NI2-WL-BL-P-C	9,0	8	14	*250	415	1030	65	Saunova	100	1900

## Saunova/Innova (NS)

HEATER MODEL	kW	SAUNA ROOM (m²)		SIZE OF HEATER (mm)			STONES (kg)	CONTROL	MINIMUM SAFETY DISTANCES	
		MIN	MAX	LENGTH	WIDTH	HEIGHT			A	B
ARI3-45NS-WL-P-C   ARI3-45NS-WL-BL-P-C	4,5	3	6	*250	415	1030	65	separate	100	1900
ARI3-60NS-WL-P-C   ARI3-60NS-WL-BL-P-C	6,0	5	9	*250	415	1030	65	separate	100	1900
ARI3-75NS-WL-P-C   ARI3-75NS-WL-BL-P-C	7,5	7	13	*250	415	1030	65	separate	100	1900
ARI3-90NS-WL-P-C   ARI3-90NS-WL-BL-P-C	9,0	8	14	*250	415	1030	65	separate	100	1900

## Mandos integrados (NB)

HEATER MODEL	kW	SAUNA ROOM (m²)		SIZE OF HEATER (mm)			STONES (kg)	CONTROL	MINIMUM SAFETY DISTANCES	
		MIN	MAX	LENGTH	WIDTH	HEIGHT			A	B
ARI3-45NB-WL-P-C   ARI3-45NB-WL-BL-P-C	4,5	3	6	*250	415	1030	65	built-in (8+4h)	100	1900
ARI3-60NB-WL-P-C   ARI3-60NB-WL-BL-P-C	6,0	5	9	*250	415	1030	65	built-in (8+4h)	100	1900
ARI3-75NB-WL-P-C   ARI3-75NB-WL-BL-P-C	7,5	7	13	*250	415	1030	65	built-in (8+4h)	100	1900
ARI3-90NB-WL-P-C   ARI3-90NB-WL-BL-P-C	9,0	8	14	*250	415	1030	65	built-in (8+4h)	100	1900

\*Profundidad cuando se instala en la pared.

## Accesorios para estufa (opcionales)



Acero inoxidable

MODEL	SIZE OF COLLAR (mm)
TH-COLLAR-ST4-WL	380 700 45



Madera Cedro (D) y Aspen (A)

MODEL	SIZE OF COLLAR (mm)
TH-COLLAR-W4-WL-D   A	385 715 45



Piedra de jabón

MODEL	SIZE OF COLLAR (mm)
TH-COLLAR-S4-WL	390 720 45



Madera Cedro (D) y Aspen (A)

MODEL	SIZE OF GUARD RAIL (mm)
ARI-GUARD-W3-WL-D   A	665 380 110

MODEL
ARI3

## Datos técnicos

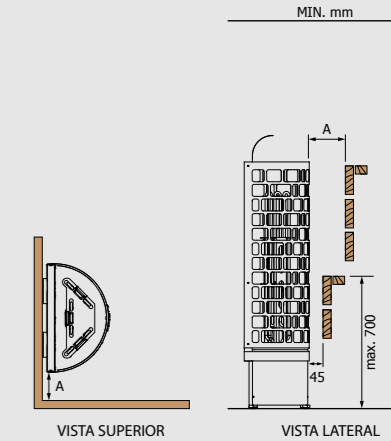

Distancias mínimas de seguridad

# Aries Corner

Aries Corner mejora el rendimiento al mejorar la distribución de la energía. El modelo Corner está diseñado para encajar perfectamente en las esquinas, lo que lo hace ideal para saunas con espacio limitado.



Aries Corner (Ni2)



Aries Corner Black (Ni2)



Aries Corner (NS)



Aries Corner Black (NS)



Aries Corner (NB)



Aries Corner Black (NB)

## Saunova (Ni2)

HEATER MODEL	kW	SAUNA ROOM (m³)		SIZE OF HEATER (mm)			STONES (KG)	CONTROL	MINIMUM SAFETY DISTANCES (mm)	
		MIN	MAX	LENGTH	WIDTH	HEIGHT			A	B
ARI3-45Ni2-CNR-P-C   ARI3-45Ni2-CNR-BL-P-C	4,5	3	6	335	*335	1000	65	Saunova	100	1900
ARI3-60Ni2-CNR-P-C   ARI3-60Ni2-CNR-BL-P-C	6,0	5	9	335	*335	1000	65	Saunova	100	1900
ARI3-75Ni2-CNR-P-C   ARI3-75Ni2-CNR-BL-P-C	7,5	7	13	335	*335	1000	65	Saunova	100	1900
ARI3-90Ni2-CNR-P-C   ARI3-90Ni2-CNR-BL-P-C	9,0	8	14	335	*335	1000	65	Saunova	100	1900

## Saunova/Innova (NS)

HEATER MODEL	kW	SAUNA ROOM (m³)		SIZE OF HEATER (mm)			STONES (KG)	CONTROL	MINIMUM SAFETY DISTANCES (mm)	
		MIN	MAX	LENGTH	WIDTH	HEIGHT			A	B
ARI3-45NS-CNR-P-C   ARI3-45NS-CNR-BL-P-C	4,5	3	6	335	*335	1000	65	separate	100	1900
ARI3-60NS-CNR-P-C   ARI3-60NS-CNR-BL-P-C	6,0	5	9	335	*335	1000	65	separate	100	1900
ARI3-75NS-CNR-P-C   ARI3-75NS-CNR-BL-P-C	7,5	7	13	335	*335	1000	65	separate	100	1900
ARI3-90NS-CNR-P-C   ARI3-90NS-CNR-BL-P-C	9,0	8	14	335	*335	1000	65	separate	100	1900

## Mandos integrados (NB)

HEATER MODEL	kW	SAUNA ROOM (m³)		SIZE OF HEATER (mm)			STONES (KG)	CONTROL	MINIMUM SAFETY DISTANCES (mm)	
		MIN	MAX	LENGTH	WIDTH	HEIGHT			A	B
ARI3-45NB-CNR-P-C   ARI3-45NB-CNR-BL-P-C	4,5	3	6	335	*335	1000	65	built-in (8+4h)	100	1900
ARI3-60NB-CNR-P-C   ARI3-60NB-CNR-BL-P-C	6,0	5	9	335	*335	1000	65	built-in (8+4h)	100	1900
ARI3-75NB-CNR-P-C   ARI3-75NB-CNR-BL-P-C	7,5	7	19	335	*335	1000	65	built-in (8+4h)	100	1900
ARI3-90NB-CNR-P-C   ARI3-90NB-CNR-BL-P-C	9,0	8	14	335	*335	1000	65	built-in (8+4h)	100	1900

\*Profundidad cuando se instala en la pared.

## Datos técnicos

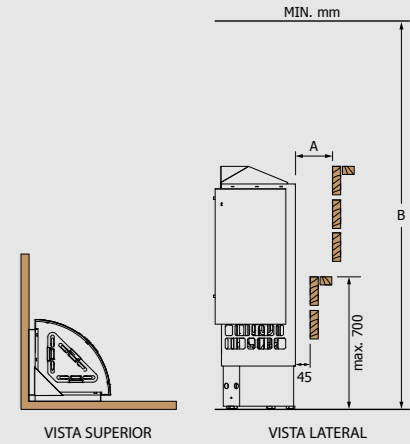

Distancias mínimas de seguridad

## Accesorios para estufa (opcionales)

Collar de integración

Protector de estufa

Acero inoxidable

MODEL	SIZE OF COLLAR (mm)
	LENGTH WIDTH HEIGHT
TH-COLLAR-ST4-CNR	235 730 45

Madera  
Cedro (D) y Aspen (A)

MODEL	SIZE OF COLLAR (mm)
	LENGTH WIDTH HEIGHT
TH-COLLAR-W4-CNR-D   A	215 670 45

Piedra de jabón

MODEL	SIZE OF COLLAR (mm)
	LENGTH WIDTH HEIGHT
TH-COLLAR-S4-CNR	475 475 45

Corner Heater Guards

MODEL	SIZE OF GUARD RAIL (mm)
	LENGTH WIDTH HEIGHT
ARI-GUARD-W3-CNR-D   A	215 635 110

Madera  
Cedro (D) y Aspen (A)

MODEL	SIZE OF GUARD RAIL (mm)
	LENGTH WIDTH HEIGHT
ARI3	

# Cubos

CUBOS es una estufa 3-en-1 que puede instalarse en el centro de la cabina, junto a la pared o en una esquina.

El protector adicional\* permite instalación mural y en esquina sin comprometer rendimiento ni seguridad. Es una estufa moderna, funcional y única en su categoría.

\*Vendido por separado



Saunova 2.0 Operated (Ni2)



Separate (NS)



Mandos integrados Control (NB)

Middle Installation

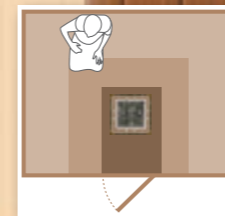

Wall Installation with Protective Cover

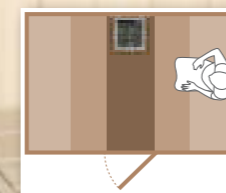

Corner Installation with Protective Cover



## Cubos

- » Rango de potencia: 4,5 – 9,0kW
- » Paneles de control disponibles: SAWO Sense, Saunova (Ni2), Innova (NS) y la versión con mandos de control incorporados (NB)
- » Carcasa: acero inoxidable
- » Túnel de aire integrado
- » Patas ajustables
- » Opcional: protector de estufa y collar de integración

## Accesorio: protector de estufa

### Instalation en la pared

El protector de la estufa convierte el modelo CUBOS en una solución mural. El reflector dirige el calor hacia las zonas más bajas de la cabina, asegurando un calentamiento uniforme incluso en espacios limitados.

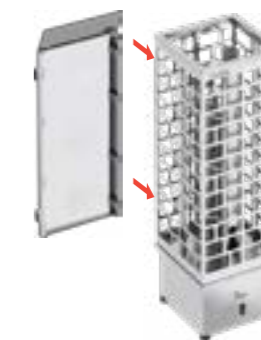

Instalación en pared with Protective Cover

MODEL	SIZE OF COVER (mm)		
	LENGTH	WIDTH	HEIGHT
CUB-PROCOV-WL	25	285	645

### Corner Installation

Cubos quickly changes to corner model with a protective cover for corner. Corner installation saves space and allows for different bench designs. The protective cover for corner set includes two pieces of covering sheet and a reflector.

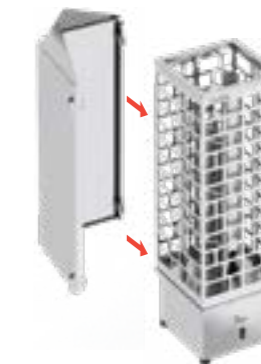

Corner Installation with Protective Cover

MODEL	SIZE OF COVER (mm)		
	LENGTH	WIDTH	HEIGHT
CUB-PROCOV-CNR	285	285	645

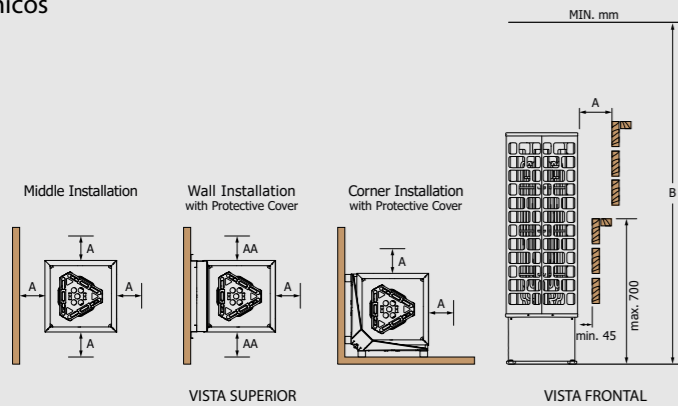

Distancias mínimas de seguridad

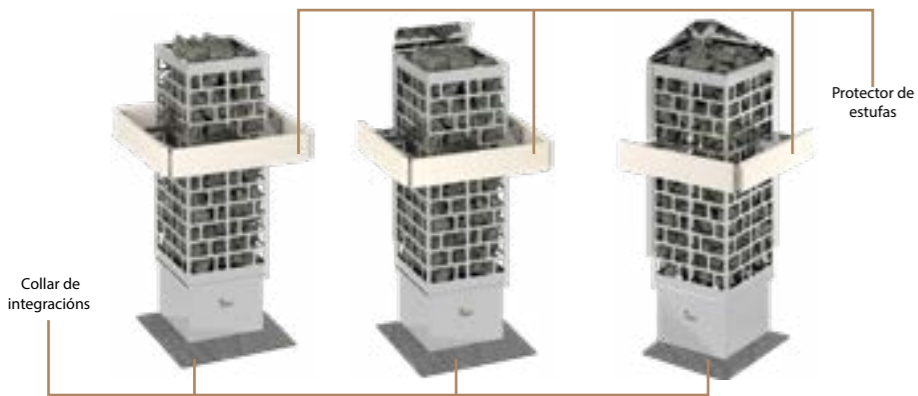

Accesorios para estufa (opcionales)

Integration Collars for Cubos

Collar de madera CUB3 Instalación en centro Cedro (D) y Aspen (A)			
MODEL	SIZE OF COLLAR LENGTH WIDTH HEIGHT (mm)		
CUB-COLLAR-W3-D	540 540 45		
CUB-COLLAR-W3-A	540 540 45		

Collar de madera CUB3 Instalación a la pared Cedro (D) y Aspen (A)			
MODEL	SIZE OF COLLAR LENGTH WIDTH HEIGHT (mm)		
CUB-COLLAR-W3-WL-D	465 465 45		
CUB-COLLAR-W3-WL-A	465 465 45		

Collar Acero inoxidable CUB3 Instalación en centro			
MODEL	SIZE OF COLLAR LENGTH WIDTH HEIGHT (mm)		
CUB-COLLAR-ST3	525 525 45		

Collar Acero inoxidable CUB3 Instalación a la pared			
MODEL	SIZE OF COLLAR LENGTH WIDTH HEIGHT (mm)		
CUB-COLLAR-ST3-WL	460 525 45		

Piedra de jabón Collar for CUB3 Instalación en centro			
MODEL	SIZE OF COLLAR LENGTH WIDTH HEIGHT (mm)		
CUB-COLLAR-S3	535 535 45		

Collar de Piedra de jabón CUB3 Instalación a la pared			
MODEL	SIZE OF COLLAR LENGTH WIDTH HEIGHT (mm)		
CUB-COLLAR-S3-WL	465 535 45		

Heater Guards for Cubos

Collar de madera CUB3 Instalación en esquina Cedro (D) y Aspen (A)			
MODEL	SIZE OF COLLAR LENGTH WIDTH HEIGHT (mm)		
CUB-COLLAR-W3-CNR-D	540 540 45		
CUB-COLLAR-W3-CNR-A	540 540 45		

Protector de madera CUB3 Instalación en centro Cedro (D) y Aspen (A)			
MODEL	SIZE OF GUARD RAIL LENGTH WIDTH HEIGHT (mm)		
CUB-GUARD-W3-D	530 530 90		
CUB-GUARD-W3-A	530 530 90		

Protector de madera CUB3 Instalación a la pared Cedro (D) y Aspen (A)			
MODEL	SIZE OF GUARD RAIL LENGTH WIDTH HEIGHT (mm)		
CUB-GUARD-W3-WL-D	460 530 90		
CUB-GUARD-W3-WL-A	460 530 90		

Protector de madera CUB3 Instalación en esquina Cedro (D) y Aspen (A)			
MODEL	SIZE OF GUARD RAIL LENGTH WIDTH HEIGHT (mm)		
CUB-GUARD-W3-CNR-D	460 460 90		
CUB-GUARD-W3-CNR-A	460 460 90		

Saunova (Ni2)

HEATER MODEL	kW	SAUNA ROOM (m²)		SIZE OF HEATER (w/ WALL INSTALLATION) (mm)						STONES (kg)	CONTROL	MINIMUM SAFETY DISTANCES				
		MIN	MAX	MIDDLE		WALL		CORNER				HEIGHT	A	AA	B	
		LENGTH	WIDTH	LENGTH	WIDTH	LENGTH	WIDTH	LENGTH	WIDTH							
CUB3-45Ni2-P-C	4,5	3	6	290	290	290	340	340	340	340	930	75	Saunova	100	100	1900
CUB3-60Ni2-P-C	6,0	5	9	290	290	290	340	340	340	340	930	75	Saunova	100	100	1900
CUB3-75Ni2-P-C	7,5	7	13	290	290	290	340	340	340	340	930	75	Saunova	100	135	1900
CUB3-90Ni2-P-C	9,0	8	14	290	290	290	340	340	340	340	930	75	Saunova	125	135	1900

Saunova/Innova (NS)

HEATER MODEL	kW	SAUNA ROOM (m²)		SIZE OF HEATER (w/ WALL INSTALLATION) (mm)						STONES (kg)	CONTROL	MINIMUM SAFETY DISTANCES				
		MIN	MAX	MIDDLE		WALL		CORNER				HEIGHT	A	AA	B	
		LENGTH	WIDTH	LENGTH	WIDTH	LENGTH	WIDTH	LENGTH	WIDTH							
CUB3-45NS-P-C	4,5	3	6	290	290	290	340	340	340	340	930	75	separate	100	100	1900
CUB3-60NS-P-C	6,0	5	9	290	290	290	340	340	340	340	930	75	separate	100	100	1900
CUB3-75NS-P-C	7,5	7	13	290	290	290	340	340	340	340	930	75	separate	100	135	1900
CUB3-90NS-P-C	9,0	8	14	290	290	290	340	340	340	340	930	75	separate	125	135	1900

Mandos integrados

HEATER MODEL	kW	SAUNA ROOM (m²)		SIZE OF HEATER (w/ WALL INSTALLATION) (mm)						STONES (kg)	CONTROL	MINIMUM SAFETY DISTANCES				
		MIN	MAX	MIDDLE		WALL		CORNER				HEIGHT	A	AA	B	
		LENGTH	WIDTH	LENGTH	WIDTH	LENGTH	WIDTH	LENGTH	WIDTH							
CUB3-45NB-P-C	4,5	3	6	290	290	290	340	340	340	340	930	75	built-in (8+4h)	100	100	1900
CUB3-60NB-P-C	6,0	5	9	290	290	290	340	340	340	340	930	75	built-in (8+4h)	100	100	1900
CUB3-75NB-P-C	7,5	7	13	290	290	290	340	340	340	340	930	75	built-in (8+4h)	100	135	1900
CUB3-90NB-P-C	9,0	8	14	290	290	290	340	340	340	340	930	75	built-in (8+4h)	125	135	1900



# Phoenix

Phoenix permite diferentes configuraciones de instalación gracias a su diseño equilibrado.

Puede instalarla en posición central, junto a la pared o integrada en los bancos, manteniendo siempre una distribución de calor uniforme y un vapor suave y estable.

- » Rango de potencia: 4,5 – 18,0kW
- » Paneles de control disponibles: SAWO Sense, Saunova (Ni2), Saunova/Innova (NS)
- » Carcasa: acero inoxidable
- » Túnel de aire integrado
- » Patas ajustables
- » Capacidad de piedras: de 85 kg a 130 kg
- » Opcional: protector de estufa y collar de integración





Phoenix (Ni2)



Phoenix (NS)

Saunova (Ni2)

HEATER MODEL	kW	SAUNA ROOM (m³)		SIZE OF HEATER (mm)			STONES (kg)	CONTROL	MINIMUM SAFETY DISTANCES (mm)	
		MIN	MAX	LENGTH	WIDTH	HEIGHT			A	B
PNX3-45Ni2-P-C	4,5	3	6	340	375	1100	85	Saunova	100	1900
PNX3-60Ni2-P-C	6,0	5	9	340	375	1100	85	Saunova	125	1900
PNX3-75Ni2-P-C	7,5	7	13	340	375	1100	85	Saunova	125	1900
PNX3-90Ni2-P-C	9,0	8	14	340	375	1100	85	Saunova	150	1900
PNX6-90Ni2-P-C	9,0	8	15	475	525	1175	130	Saunova	150	1900

Saunova/Innova (NS)

HEATER MODEL	kW	SAUNA ROOM (m³)		SIZE OF HEATER (mm)			STONES (kg)	CONTROL	MINIMUM SAFETY DISTANCES (mm)	
		MIN	MAX	LENGTH	WIDTH	HEIGHT			A	B
PNX3-45NS-P-C	4,5	3	6	340	375	1100	85	separate	100	1900
PNX3-60NS-P-C	6,0	5	9	340	375	1100	85	separate	125	1900
PNX3-75NS-P-C	7,5	7	12	340	375	1100	85	separate	125	1900
PNX3-90NS-P-C	9,0	8	14	340	375	1100	85	separate	150	1900
PNX6-90NS-P-C	9,0	8	15	475	525	1175	130	separate	150	1900
PNX6-105NS-P	10,5	9	16	475	525	1175	130	separate	150	1900
PNX6-120NS-P	12,0	11	18	475	525	1175	130	separate	150	2100
PNX6-150NS-P	15,0	14	25	475	525	1175	130	separate	150	2100
PNX6-180NS-P	18,0	18	28	475	525	1175	130	separate	175	2100

Datos técnicos

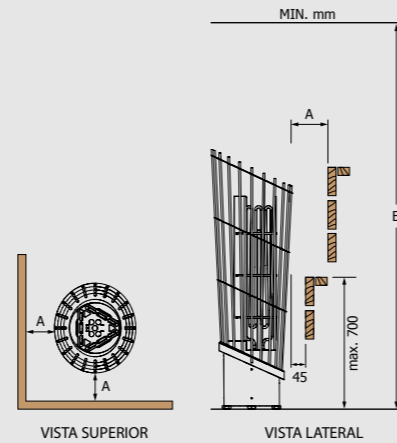

Distancias mínimas de seguridad



# Heaterking

Las estufas Heaterking, diseñadas por Stefan Lindfors, ofrecen un calor de "tamaño rey" y destacan por su cubierta de diseño con fuerte personalidad.

El exclusivo patrón Junglefire en acero inoxidable aporta un acabado distintivo, moderno y estilizado.

La gama Heaterking está disponible en tres versiones: Round, Wall y Corner.

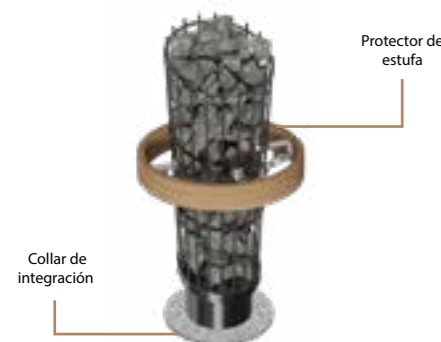

Accesorios para estufa (opcionales)

Integration Collars for Phoenix



MODEL	SIZE OF COLLAR (mm)		
	LENGTH	WIDTH	HEIGHT
TH-COLLAR-V2-ST4	420	420	105
TH-COLLAR-ST4	540	540	45
TH-COLLAR-ST9	640	640	45

Heater Guards for Phoenix



MODEL	SIZE OF COLLAR (mm)		
	LENGTH	WIDTH	HEIGHT
TH-COLLAR-S4	560	560	45
TH-COLLAR-S9	690	690	45

## Heaterking ROUND

- » Rango de potencia: 3,0 – 24,0kW
- » Paneles de control disponibles: SAWO Sense, Saunova/Innova (NS)
- » Carcasa: acero inoxidable con el elaborado patrón Junglefire
- » Túnel de aire integrado
- » Capacidad de piedras: de 60 kg a 360 kg
- » Patas ajustables
- » Opcional: protector de estufa



(NS)

## Heaterking WALL

- » Rango de potencia: 3,0 – 24,0kW
- » Paneles de control disponibles: Saunova/Innova (NS)
- » Carcasa: acero inoxidable con el elaborado patrón Junglefire
- » Túnel de aire integrado
- » Capacidad de piedras: de 60 kg a 250 kg
- » Wall type Acero inoxidable Carcasa
- » Patas ajustables
- » Reflector térmico incluido



(NS)

## Heaterking CORNER

- » Rango de potencia: 3,5 – 12,0kW
- » Paneles de control disponibles: Saunova/Innova (NS)
- » Carcasa: acero inoxidable con el elaborado patrón Junglefire
- » Túnel de aire integrado
- » Capacidad de piedras: de 45 kg a 160 kg
- » Corner-type Acero inoxidable Carcasa
- » Patas ajustables
- » Reflector térmico incluido



(NS)

Datos técnicos



Heaterking ROUND

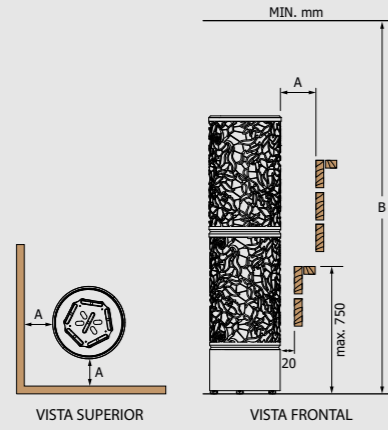

Distancias mínimas de seguridad

Datos técnicos



Heaterking WALL

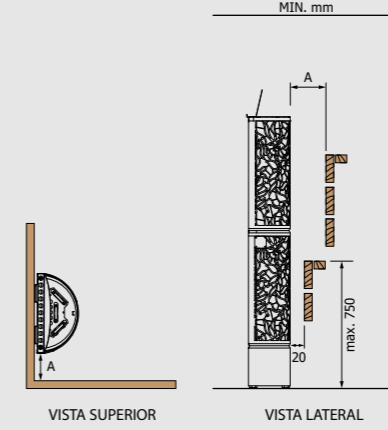

Distancias mínimas de seguridad

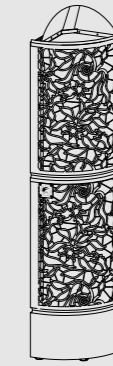

Heaterking CORNER

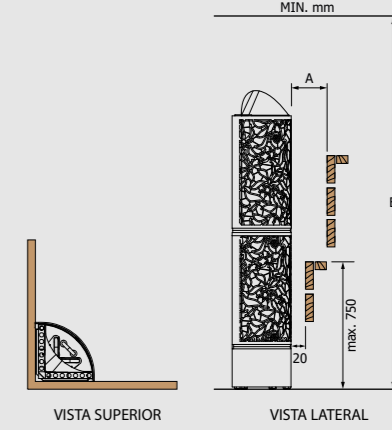

Distancias mínimas de seguridad

Saunova/Innova (NS)

HEATER MODEL	kW	SAUNA ROOM (m²)		SIZE OF HEATER (mm)			STONES (kg)		CONTROL	MINIMUM SAFETY DISTANCES (mm)	
		MIN	MAX	LENGTH	WIDTH	HEIGHT	Without Stone Spacer	With Stone Spacer		A	B
DRFT2-30NS-P	3,0	2	4	250	250	1325	70	60	separate	150	1900
DRFT3-35NS-P-C	3,5	3	6	250	250	1325	70	60	separate	100	1900
DRFT3-45NS-P-C	4,5	3	6	250	250	1325	70	60	separate	100	1900
DRFT3-60NS-P-C	6,0	5	8	250	250	1325	70	60	separate	150	1900
DRFT4-60NS-P-C	6,0	5	9	295	295	1325	105	90	separate	100	1900
DRFT5-80NS-P-C	8,0	8	14	295	295	1325	105	90	separate	200	1900
DRFT5-90NS-P-C	9,0	8	14	295	295	1325	105	90	separate	200	1900
DRFT6-80NS-P-C	8,0	7	14	355	355	1325	160	100	separate	100	1900
DRFT6-90NS-P-C	9,0	8	15	355	355	1325	160	100	separate	100	1900
DRFT6-105NS-P	10,5	9	16	355	355	1325	160	100	separate	150	1900
DRFT6-120NS-P	12,0	11	18	355	355	1325	160	100	separate	200	2100
DRFT9-105NS-P	10,5	10	16	425	425	1325	230	165	separate	150	2100
DRFT9-120NS-P	12,0	11	20	425	425	1325	230	165	separate	150	2100
DRFT9-150NS-P	15,0	14	25	425	425	1325	230	165	separate	200	2100
DRFT9-180NS-P	18,0	18	28	425	425	1325	230	165	separate	200	2100
DRFT12-150NS-P	15,0	15	26	525	525	1325	360	220	separate	200	2300
DRFT12-180NS-P	18,0	18	30	525	525	1325	360	220	separate	200	2300
DRFT12-210NS-P	21,0	22	35	525	525	1325	360	220	separate	200	2300
DRFT12-240NS-P	24,0	24	40	525	525	1325	360	220	separate	200	2300



Heater Guard Rail

Saunova/Innova (NS)

HEATER MODEL	kW	SAUNA ROOM (m²)		SIZE OF HEATER (mm)			STONES (kg)		CONTROL	MINIMUM SAFETY DISTANCES (mm)	
		MIN	MAX	LENGTH	WIDTH	HEIGHT	Without Stone Spacer	With Stone Spacer		A	B
DRFT3-35NS-WL-P-C	3,5	3	6	*220	395	1440	80	60	separate	100	1900
DRFT3-45NS-WL-P-C	4,5	3	6	*220	395	1440	80	60	separate	100	1900
DRFT3-60NS-WL-P-C	6,0	5	8	*220	395	1440	80	60	separate	100	1900
DRFT6-80NS-WL-P-C	8,0	7	14	*300	550	1475	160	105	separate	100	1900
DRFT6-90NS-WL-P-C	9,0	8	15	*300	550	1475	160	105	separate	100	1900
DRFT6-105NS-WL-P	10,5	9	16	*300	550	1475	160	105	separate	100	1900
DRFT6-120NS-WL-P	12,0	11	18	*300	550	1475	160	105	separate	100	2100
DRFT9-105NS-WL-P	10,5	10	16	*350	650	1510	180	115	separate	100	2100
DRFT9-120NS-WL-P	12,0	11	20	*350	650	1510	180	115	separate	100	2100
DRFT9-150NS-WL-P	15,0	14	25	*350	650	1510	180	115	separate	100	2100
DRFT9-180NS-WL-P	18,0	18	28	*350	650	1510	180	115	separate	100	2100
DRFT12-150NS-WL-P	15,0	15	26	*420	790	1545	250	165	separate	100	2300
DRFT12-180NS-WL-P	18,0	18	30	*420	790	1545	250	165	separate	100	2300
DRFT12-210NS-WL-P	21,0	22	35	*420	790	1545	250	165	separate	100	2300
DRFT12-240NS-WL-P	24,0	24	40	*420	790	1545	250	165	separate	100	2300

\*Profundidad cuando se instala en la pared.

Saunova/Innova (NS)

HEATER MODEL	kW	SAUNA ROOM (m²)		SIZE OF HEATER (mm)			STONES (kg)		CONTROL	MINIMUM SAFETY DISTANCES (mm)	
		MIN	MAX	LENGTH	WIDTH	HEIGHT	Without Stone Spacer	With Stone Spacer		A	B
DRFT3-35NS-CNR-P-C	3,5	3	6	*300	300	1410	70	45	separate	100	1900
DRFT3-45NS-CNR-P-C	4,5	3	6	*300	300	1410	70	45	separate	100	1900
DRFT3-60NS-CNR-P-C	6,0	5	8	*300	300	1410	70	45	separate	100	1900
DRFT6-80NS-CNR-P-C	8,0	7	14	*410	410	1430	160	100	separate	100	1900
DRFT6-90NS-CNR-P-C	9,0	8	15	*410	410	1430	160	100	separate	100	1900
DRFT6-105NS-CNR-P	10,5	9	16	*410	410	1430	160	100	separate	100	1900
DRFT6-120NS-CNR-P	12,0	11	18	*410	410	1430	160	100	separate	100	2100

\*Profundidad cuando se instala en la pared.

Accesorios para estufa (opcionales)

Heaterking Round Heater Guards



Protector de madera para DRFT 2 y 3 H.E Round Cedro (D) y Aspen (A)

MODEL	SIZE OF GUARD RAIL (mm)	LENGTH	WIDTH	HEIGHT
DRFT-W2-D	510	510	105	105
DRFT-W2-A	510	510	105	105



Protector de madera para DRFT 4 y 5 H.E Round Cedro (D) y Aspen (A)

MODEL	SIZE OF GUARD RAIL (mm)	LENGTH	WIDTH	HEIGHT
DRFT-W4-D	560	560	105	105
DRFT-W4-A	560	560	105	105



Protector de madera para DRFT 6 H.E Round Cedro (D) y Aspen (A)

MODEL	SIZE OF GUARD RAIL (mm)	LENGTH	WIDTH	HEIGHT
DRFT-W6-D	620	620	105	105
DRFT-W6-A	620	620	105	105



Protector de madera para DRFT 9 H.E Round Cedro (D) y Aspen (A)

MODEL	SIZE OF GUARD RAIL (mm)	LENGTH	WIDTH	HEIGHT
DRFT-W9-D	690	690	105	105
DRFT-W9-A	690	690	105	105



Protector de madera para DRFT 12 H.E Round Cedro (D) y Aspen (A)

MODEL	SIZE OF GUARD RAIL (mm)	LENGTH	WIDTH	HEIGHT
DRFT-W12-D	790	790	105	105
DRFT-W12-A	790	790	105	105



# Fiberjungle



(NS)

Fiberjungle, diseñada por Stefan Lindfors, presenta una estética única con un recubrimiento de fibra negra de gran impacto visual.

Su presencia atrevida y elegante, incorpora un revestimiento seguro al tacto que mejora la protección de la estufa.

- » Rango de potencia: 4,5 – 9,0 kW
- » Paneles de control disponibles: SAWO Sense, Saunova/Innova (NS)
- » Patas ajustables

## Datos técnicos



Fiberjungle

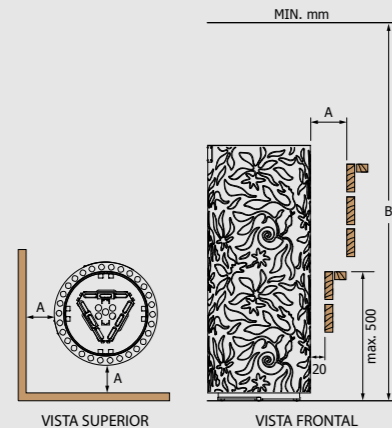

Distancias mínimas de seguridad

## Saunova/Innova (NS)

HEATER MODEL	kW	SAUNA ROOM (m²)		SIZE OF HEATER (mm)			STONES (kg)	CONTROL	MINIMUM SAFETY DISTANCES	
		MIN	MAX	LENGTH	WIDTH	HEIGHT			A	B
DRF3-45NS-P-C	4,5	3	6	300	300	930	60	separate	100	1900
DRF3-60NS-P-C	6,0	5	9	300	300	930	60	separate	100	1900
DRF3-75NS-P-C	7,5	7	12	300	300	930	60	separate	100	1900
DRF3-90NS-P-C	9,0	8	13	300	300	930	60	separate	100	1900



# Estufas para sauna Línea SUELO

Línea Suelo incluye estufas de alto rendimiento, elegantes, robustas y diseñadas para un funcionamiento duradero. Las estufas garantizan una distribución óptima del calor y un rendimiento eficiente.

Gracias a sus múltiples opciones de instalación dentro de la cabina, permiten personalizar el diseño de la sauna y adaptarlo a su gusto.

# Nordex Pro

Nordex Pro es el modelo más reciente de la familia Nordex. Está diseñado para ofrecer un rendimiento duradero.

Su compartimento de piedras separado protege las resistencias y ayuda a prolongar la vida útil de la estufa.

La bandeja extraíble tipo cassette hace que el mantenimiento sea muy sencillo.

Aunque solo existe un tamaño físico, se puede conectar con hasta dos unidades más, alcanzando una potencia total de 27,0 kW para saunas más grandes.



## Datos técnicos

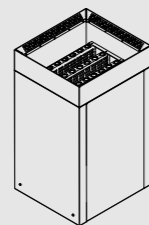

Nordex Pro

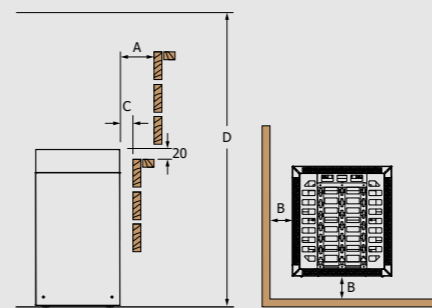

VISTA LATERAL VISTA SUPERIOR  
Distancias mínimas de seguridad



El Kit de Conexión Nordex Pro es necesario para conectar dos o más unidades Pro.

\*Vendido por separado

La bandeja extraíble permite al usuario cambiar, revisar o realizar el mantenimiento de las resistencias con facilidad. También facilita la sustitución de las piedras, ya que no entran en contacto con las resistencias eléctricas.

## Saunova/Innova (NS)

HEATER MODEL	kW	SAUNA ROOM		SIZE OF HEATER			STONES (KG)	CONTROL	MINIMUM SAFETY DISTANCES			
		MIN (m³)	MAX (m³)	LENGTH (mm)	WIDTH (mm)	HEIGHT (mm)			A	B	C	D
NRN-PRO-60NS-BL-Z-C	6,0	5	9	410	370	705	60	separate	80	80	20	1900
NRN-PRO-80NS-BL-Z-C	8,0	7	13	410	370	705	60	separate	80	80	20	1900
NRN-PRO-90NS-BL-Z-C	9,0	8	14	410	370	705	60	separate	80	80	20	1900



Nordex Pro (NS)

- » Rango de potencia: 6,0 – 9,0kW
- » Paneles de control disponibles: SAWO Sense, Saunova/Innova (NS)
- » Patas ajustables

# Nordex Pro Combi

El Nordex Pro Combi sigue la tradición de la gama Nordex,

pero con un diseño mejorado que combina una estufa eficiente con la comodidad adicional del vaporizador.

Su depósito de agua integrado genera una humedad suave, y la separación entre piedras y resistencias aumenta la durabilidad del equipo.

La bandeja extraíble facilita el mantenimiento, y el modelo puede conectarse con hasta dos unidades adicionales para alcanzar una potencia total de 27,0 kW de estufa + 6,0 kW de vaporizador.



## Datos técnicos

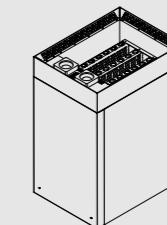

Nordex Pro Combi

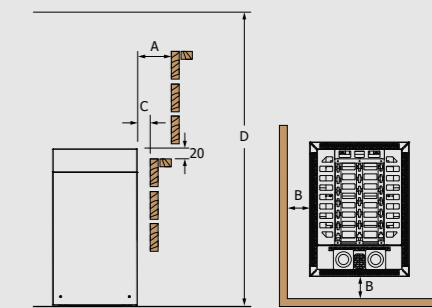

VISTA LATERAL VISTA SUPERIOR  
Distancias mínimas de seguridad



El Kit de Conexión Nordex Pro es necesario para conectar dos o más unidades Pro.

\*Vendido por separado

La bandeja extraíble permite al usuario cambiar, revisar o realizar el mantenimiento de las resistencias con facilidad. También facilita la sustitución de las piedras, ya que no entran en contacto con las resistencias eléctricas.

## Saunova/Innova (NS)

HEATER MODEL	kW HEATER	kW TANK	SAUNA ROOM		SIZE OF HEATER			STONES (KG)	CONTROL	MINIMUM SAFETY DISTANCES			
			MIN (m³)	MAX (m³)	LENGTH (mm)	WIDTH (mm)	HEIGHT (mm)			A	B	C	D
NRNC-PRO-60NS-BL-Z-C	6,0	1 x 0,8	5	9	500	370	705	60	separate	80	80	20	1900
NRNC-PRO-80NS-BL-Z-C	8,0	1 x 2,0	7	13	500	370	705	60	separate	80	80	20	1900
NRNC-PRO-90NS-BL-Z-C	9,0	1 x 2,0	8	14	500	370	705	60	separate	80	80	20	1900



Nordex Pro Combi (NS)

- » Rango de potencia: 6,0 – 9,0kW
- » Paneles de control disponibles: SAWO Sense, Saunova/Innova (NS)
- » Cubetas de aroma integradas
- » Patas ajustables
- » Vaporizador de 0,8 kW



# Nordex S

Nordex S es una versión actualizada del modelo Nordex Floor. Su diseño más delgado facilita la instalación en diferentes tipos de sauna.

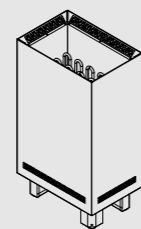

Nordex S

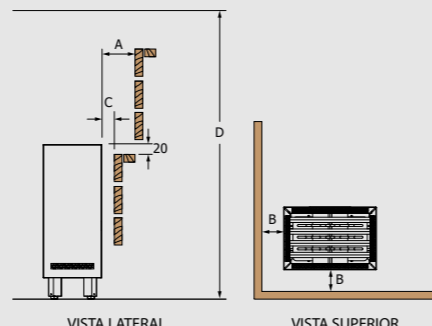

VISTA LATERAL VISTA SUPERIOR  
Distancias mínimas de seguridad

- » Rango de potencia: 6,0 – 9,0kW
- » Paneles de control disponibles: SAWO Sense, Saunova/Innova (NS)
- » Patas ajustables

## Saunova/Innova (NS)

HEATER MODEL	kW	SAUNA ROOM (m³)		SIZE OF HEATER (mm)			STONES (kg)	CONTROL	MINIMUM SAFETY DISTANCES			
		MIN	MAX	LENGTH	WIDTH	HEIGHT			A	B	C	D
NRNS-60NS-Z-C	6,0	5	9	270	395	710	18 - 25	separate	50	50	5	1900
NRNS-60NS-BL-Z-C	6,0	5	9	270	395	710	18 - 25	separate	50	50	5	1900
NRNS-80NS-Z-C	8,0	7	13	270	395	710	18 - 25	separate	80	80	5	1900
NRNS-80NS-BL-Z-C	8,0	7	13	270	395	710	18 - 25	separate	80	80	5	1900
NRNS-90NS-Z-C	9,0	8	14	270	395	710	18 - 25	separate	80	80	5	1900
NRNS-90NS-BL-Z-C	9,0	8	14	270	395	710	18 - 25	separate	80	80	5	1900



Nordex S (NS)



Nordex S Black (NS)

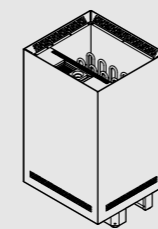

Nordex S Combi



VISTA LATERAL VISTA SUPERIOR  
Distancias mínimas de seguridad

- » Rango de potencia: 6,0 – 9,0kW
- » Paneles de control disponibles: SAWO Sense, Saunova/Innova (NS)
- » Depósito de agua con vaporizador de 0,8 kW o 2,0 kW
- » Cubetas de aroma integradas
- » Patas ajustables

## Saunova/Innova (NS)

HEATER MODEL	kW HEATER	kW TANK	SAUNA ROOM (m³)		SIZE OF HEATER (mm)			STONES (kg)	CONTROL	MINIMUM SAFETY DISTANCES			
			MIN	MAX	LENGTH	WIDTH	HEIGHT			A	B	C	D
NRNSC-60NS-Z-C	6,0	1 x 0,8	5	9	360	395	710	18 - 25	separate	5	50	5	1900
NRNSC-60NS-BL-Z-C	6,0	1 x 0,8	5	9	360	395	710	18 - 25	separate	5	50	5	1900
NRNSC-80NS-Z-C	8,0	1 x 2,0	7	13	360	395	710	18 - 25	separate	5	80	5	1900
NRNSC-80NS-BL-Z-C	8,0	1 x 2,0	7	13	360	395	710	18 - 25	separate	5	80	5	1900
NRNSC-90NS-Z-C	9,0	1 x 2,0	8	14	360	395	710	18 - 25	separate	5	80	5	1900
NRNSC-90NS-BL-Z-C	9,0	1 x 2,0	8	14	360	395	710	18 - 25	separate	5	80	5	1900



Nordex S Combi (NS)



Nordex S Combi Black (NS)

# Nordex S Combi

Nordex S Combi está disponible ahora en una versión con vaporizador. Permite equilibrar el calor intenso mediante el sistema Combi, que aporta un nivel adicional de humedad. La estufa también está disponible con carcasa en acero negro.



# Nordex Floor

Nordex Floor es una estufa de instalación en el suelo, con un diseño sencillo y un rendimiento de calidad.

Está disponible con carcasa de acero inoxidable o carcasa metálica en color negro.



## Datos técnicos

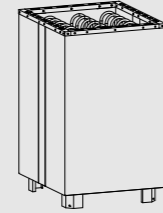

Nordex Floor

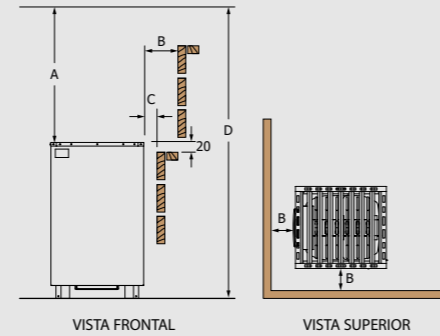

Distancias mínimas de seguridad

- » Rango de potencia: 9,0 – 24,0kW
- » Paneles de control disponibles: SAWO Sense, Saunova/Innova (NS)
- » Patas ajustables



### Saunova/Innova (NS)

HEATER MODEL	kW	SAUNA ROOM		SIZE OF HEATER			STONES (kg)	CONTROL	MINIMUM SAFETY DISTANCES			
		MIN (m³)	MAX	LENGTH	WIDTH	HEIGHT			A	B	C	D
NRNF-90NS-Z   NRNF-90NS-BL-Z	9,0	8	14	450	400	670	45	separate	1200	120	50	1900
NRNF-105NS-Z   NRNF-105NS-BL-Z	10,5	9	15	450	400	670	45	separate	1200	120	60	1900
NRNF-120NS-Z   NRNF-120NS-BL-Z	12,0	10	18	450	400	670	45	separate	1400	130	70	2100
NRNF-150NS-Z   NRNF-150NS-BL-Z	15,0	13	23	595	400	670	55	separate	1400	160	100	2100
NRNF-180NS-Z   NRNF-180NS-BL-Z	18,0	17	29	595	400	670	55	separate	1400	160	100	2100
NRNF-180NS-V12-Z   NRNF-180NS-BL-V12-Z	18,0	18	30	740	400	670	75	separate	1400	160	100	2100
NRNF-210NS-V12-Z   NRNF-210NS-BL-V12-Z	21,0	22	35	740	400	670	75	separate	1400	160	100	2100
NRNF-240NS-V12-Z   NRNF-240NS-BL-V12-Z	24,0	26	42	740	400	670	75	separate	1400	160	100	2100



Nordex Floor (NS)



Nordex Floor Black (NS)

## Datos técnicos

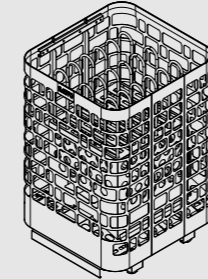

Krios Floor

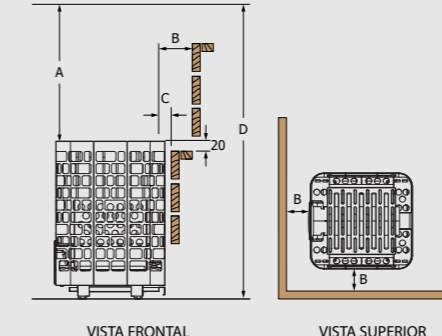

Distancias mínimas de seguridad

- » Rango de potencia: 9,0 – 24,0kW
- » Paneles de control disponibles: SAWO Sense, Saunova/Innova (NS)
- » Patas ajustables



### Saunova/Innova (NS)

HEATER MODEL	kW	SAUNA ROOM		SIZE OF HEATER			STONES (kg)	CONTROL	MINIMUM SAFETY DISTANCES			
		MIN (m³)	MAX	LENGTH	WIDTH	HEIGHT			A	B	C	D
KRFS-90NS-P	9,0	8	14	500	460	715	160	separate	1200	100	20	1900
KRFS-105NS-P	10,5	9	15	500	460	715	160	separate	1200	100	20	1900
KRFS-120NS-P	12,0	10	18	500	460	715	160	separate	1400	100	20	2100
KRFS-150NS-P	15,0	13	23	680	460	715	210	separate	1400	100	160	2100
KRFS-180NS-P	18,0	17	29	680	460	715	210	separate	1400	100	160	2100
KRFS-180NS-V12-P	18,0	18	30	860	460	715	260	separate	1400	160	100	2100
KRFS-210NS-V12-P	21,0	22	35	860	460	715	260	separate	1400	160	100	2100
KRFS-240NS-V12-P	24,0	26	42	860	460	715	260	separate	1400	160	100	2100



Krios Floor (NS)

# Krios Floor

Nuestra reconocida estufa Krios está ahora disponible también en versión de suelo, con el característico diseño SAWO. Gracias a su mayor capacidad de piedras, Krios Floor produce más vapor y ofrece una experiencia de sauna más intensa y envolvente.



# Helius

Helius, gracias a su diseño delgado, ofrece una gran flexibilidad en cuanto a su colocación dentro de la sauna.

Esta estufa "oculta" puede instalarse detrás de los bancos utilizando un separador de pared.

Incluye una cubeta de piedra que permite aumentar la humedad en la sauna cuando se vierte agua sobre ella.

El modelo requiere una distancia de seguridad mucho menor de lo habitual (mín. 5 mm). Añadiendo una capota Helius adicional, esta distancia puede reducirse prácticamente al mínimo.

Gracias a su avanzado diseño de flujo de aire, Helius necesita menos piedras, lo que mejora la circulación del aire y aumenta la eficiencia del calentamiento.

- » Rango de potencia: 4,5 - 9,0kW
- » Paneles de control disponibles: SAWO Sense, Saunova/Innova (NS)
- » Incluye: Cubeta de agua con manguera
- » Opcional: protector de estufa y capota



## Datos técnicos

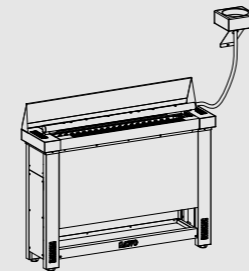

Helius

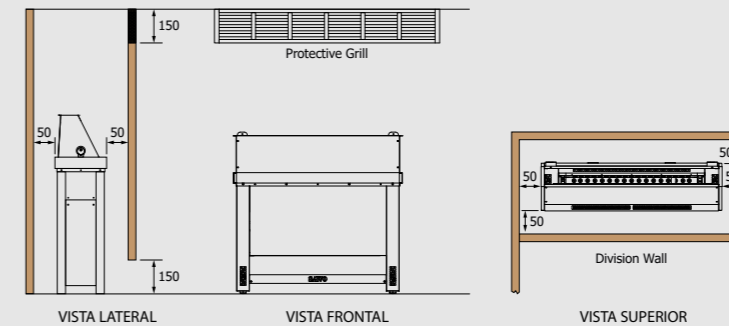

Distancias mínimas de seguridad (Wall Divider)

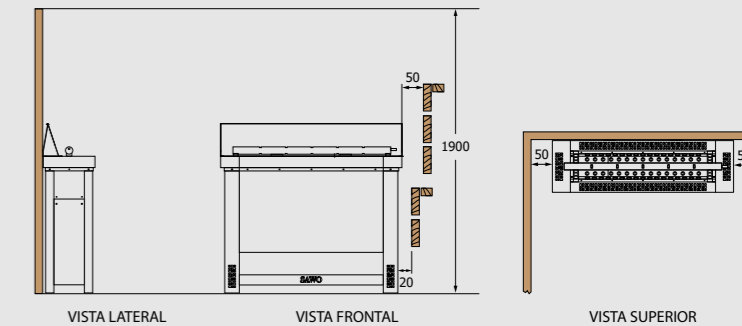

Distancias mínimas de seguridad (Wall Installation)

## Saunova/Innova (NS)

HEATER MODEL	kW	SAUNA ROOM		SIZE OF HEATER			STONES (kg)	CONTROL
		MIN (m³)	MAX (m³)	LENGTH (mm)	WIDTH (mm)	HEIGHT (mm)		
HES-45NS-G-P-C	4,5	3	6	230	860	655	17	separate
HES-60NS-G-P-C	6,0	5	9	230	860	655	17	separate
HES-75NS-G-P-C	7,5	7	13	230	860	655	17	separate
HES-90NS-G-P-C	9,0	8	14	230	860	655	17	separate

## Helius con capota (Opcional)

- » Mantenga un espacio para un separador de pared y un hueco para poder colocar la estufa detrás o debajo de los bancos.

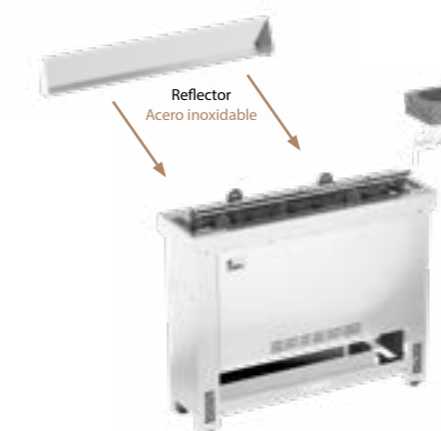

## Otras características:

- » Puede instalarse como estufa de suelo o montada en la pared
- » Las piedras no entran en contacto con las resistencias eléctricas
- » Incluye accesorio de agua (embudo y manguera) para instalaciones en pared con separador
- » Capacidad para 17 kg de piedras
- » Bandeja recoge-agua incluida
- » Patas ajustables

## Accesorios para estufa (opcionales)

### Helius Capota



Helius Capota Acero inoxidable

MODEL	SIZE OF HOOD (mm)		
	LENGTH	WIDTH	HEIGHT
HP68-008	85	840	290

### Helius Protectores



Madera Cedro (D) y Aspen (A)

MODEL	SIZE OF GUARD RAIL (mm)		
	LENGTH	WIDTH	HEIGHT
HES-GUARD-W-D	280	910	90
HES-GUARD-W-A	280	910	90

### Helius Capota



### Protector de estufa



# Taurus D

Taurus D revoluciona el concepto de estufa de sauna al ofrecer dos o más opciones de potencia en un mismo equipo. Está diseñada para un uso intensivo y continuado en spas y piscinas, tanto públicas como privadas.

El modelo incorpora un avanzado sistema de sensores que detecta de forma temprana cualquier fallo en las resistencias. Su contenedor de piedras mantiene las piedras separadas de las resistencias eléctricas, lo que prolonga la vida útil del equipo.

Además, la estufa cuenta con una bandeja extraíble tipo cassette, que facilita cualquier tarea de mantenimiento, ya sea sustituir las piedras o cambiar las resistencias.

Este diseño reduce el tiempo de inactividad, disminuye los costes operativos y garantiza un rendimiento duradero.

- » Rango de potencia: 9,0 – 36,0kW
- » Paneles de control disponibles: SAWO Sense, Saunova/Innova (NS)
- » Patas ajustables



## Datos técnicos

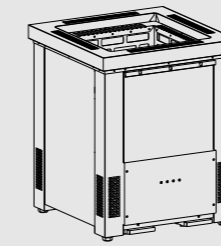

Taurus D

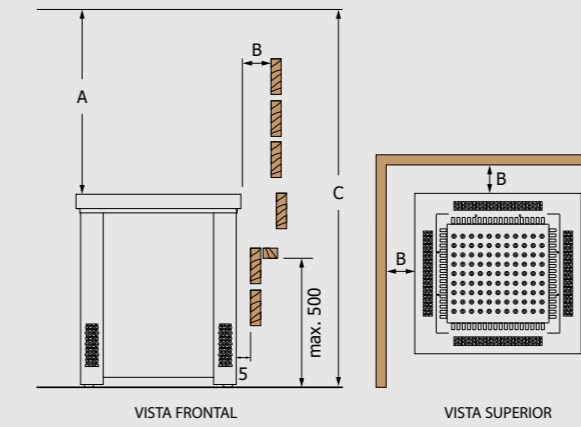

VISTA FRONTAL VISTA SUPERIOR  
Distancias mínimas de seguridad

La bandeja extraíble permite al usuario cambiar, revisar o realizar el mantenimiento de las resistencias con facilidad. También facilita la sustitución de las piedras, ya que no entran en contacto con las resistencias eléctricas.

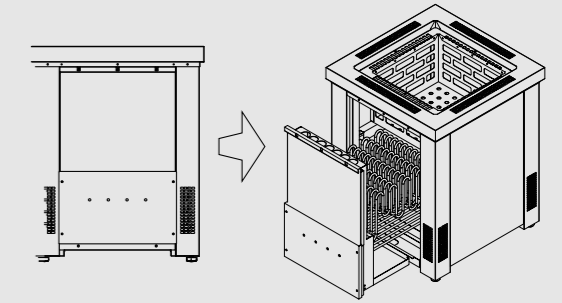

Taurus D (NS)



TRD-270/300/330/360NS-G-P

## Accesorios para estufa (opcionales)

### Taurus Protectores



Madera Cedro (D), Aspen (A), y Black (BL)

Protector de madera para TRD-90/120 Cedro (D), Aspen (A), y Black (BL)

Protector de madera para TRD-180/210/240 Cedro (D), Aspen (A), y Black (BL)

MODEL	SIZE OF GUARD RAIL (mm)		
	LENGTH	WIDTH	HEIGHT
TAU-GUARD-W9-D   A   BL	555	105	135

MODEL	SIZE OF GUARD RAIL (mm)		
	LENGTH	WIDTH	HEIGHT
TAU-GUARD-V12-D   A   BL	105	705	135

## Saunova/Innova (NS)

HEATER MODEL	kW	SAUNA ROOM (m²)		SIZE OF HEATER (mm)			STONES (kg)	CONTROL	MINIMUM SAFETY DISTANCES		
		MIN	MAX	LENGTH	WIDTH	HEIGHT			A	B	C
TRD-90/120NS-G-P	9,0   12,0	8	18	555	555	690	50	separate	1210	5/*50	1900
TRD-150/180NS-G-P	15,0   18,0	13	29	555	705	690	65-75	separate	1410	5/*50	2100
TRD-180/210/240NS-G-P	18,0   21,0   24,0	18	42	555	970	690	90-100	separate	1410	5/*50	2100
TRD-270/300/330/360NS-G-P	27,0   30,0   33,0   36,0	32	75	555	1385	690	150	separate	1410	5/*50	2100

\* Para uso publico

### Protector de estufas



# Taurus D Combi

Con la estufa Taurus D Combi, la experiencia wellness es ahora aún más fácil de personalizar. Este modelo combina un generador de vapor con la innovación de Taurus D: dos o más opciones de potencia en un mismo equipo.

Con Taurus D Combi, los usuarios pueden disfrutar tanto de una sauna tradicional como de una sauna de vapor. Incluye una cubeta para esencias, que permite crear un vapor aromático utilizando aceites esenciales o fragancias favoritas.

El equipo incorpora un sistema de detección de nivel de agua que avisa cuando el nivel es bajo, igual que en otros modelos Combi. La función de llenado automático también está disponible de forma opcional para una mayor comodidad.

- » Rango de potencia: 9,0 – 36,0 kW
- » Paneles de control disponibles: SAWO Sense, Saunova/Innova (NS)
- » Carcasa en acero negro
- » Protección sobrecalentamiento automático
- » Cubetas de aroma integradas
- » Patas ajustables
- » Opcional: Protector de estufa
- » Opcional: llenado automático para el depósito de agua



## Datos técnicos

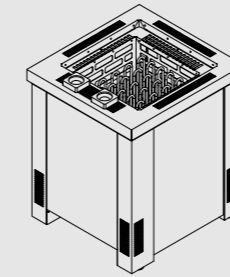

Taurus D Combi

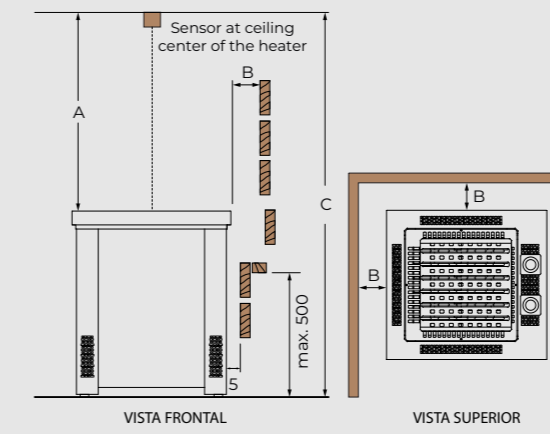

Distancias mínimas de seguridad

La bandeja extraíble permite al usuario cambiar, revisar o realizar el mantenimiento de las resistencias con facilidad. También facilita la sustitución de las piedras, ya que no entran en contacto con las resistencias eléctricas.

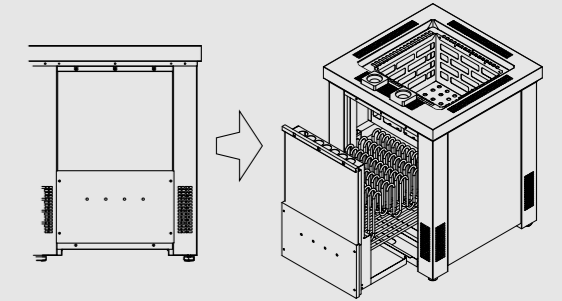

Taurus D Combi (NS)



TRDC-270/300/330/360NS-G-P

## Saunova/Innova (NS)

HEATER MODEL	KW HEATER	KW TANK	SAUNA ROOM (m³)		SIZE OF HEATER (mm)			STONES (kg)	CONTROL	MINIMUM SAFETY DISTANCES		
			MIN	MAX	LENGTH	WIDTH	HEIGHT			A	B	C
TRDC-90/120NS-G-P	9,0   12,0	1 x 2,0	8	18	595	555	690	50	separate	1210	5/*50	1900
TRDC-150/180NS-G-P	15,0   18,0	1 x 2,0	13	29	595	705	690	65 - 75	separate	1410	5/*50	2100
TRDC-180/210/240NS-G-P	18,0   21,0   24,0	2 x 2,0	18	42	595	970	690	90 - 100	separate	1410	5/*50	2100
TRDC-270/300/330/360NS-G-P	27,0   30,0   33,0   36,0	3 x 2,0	32	75	595	1385	690	150	separate	1410	5/*50	2100

\*Para uso comercial.

# Savonia

Los modelos Savonia están diseñados para un uso intensivo y requieren muy poco tiempo de cuidado y mantenimiento. Además, pueden alojar una gran cantidad de piedras, lo que permite disfrutar de una experiencia de sauna más suave y a menor temperatura.

Las estufas están disponibles en dos versiones: la versión estándar y la versión con revestimiento de fibra seguro al tacto.

- » Rango de potencia: 9,0 – 24,0kW
- » Paneles de control disponibles: Saunova/Innova (NS)
- » Patas ajustables



## Datos técnicos

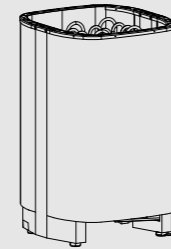

Savonia

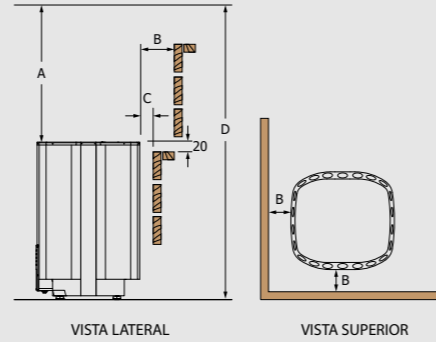

VISTA LATERAL VISTA SUPERIOR  
Distancias mínimas de seguridad



## Saunova/Innova (NS)

HEATER MODEL	kW	SAUNA ROOM		SIZE OF HEATER			STONES (kg)	CONTROL	MINIMUM SAFETY DISTANCES			
		MIN (m³)	MAX (m³)	LENGTH (mm)	WIDTH (mm)	HEIGHT (mm)			A	B	C	D
SAV-90NS-Z   SAV-90NS-P-F	9,0	8	14	440	420	655	50 - 60	separate	1200	110	50	1900
SAV-105NS-Z   SAV-105NS-P-F	10,5	9	15	440	420	655	50 - 60	separate	1200	120	60	1900
SAV-120NS-Z   SAV-120NS-P-F	12,0	10	18	440	420	655	50 - 60	separate	1400	130	70	2100
SAV-150NS-Z   SAV-150NS-P-F	15,0	13	23	590	420	655	60 - 75	separate	1400	160	100	2100
SAV-180NS-Z   SAV-180NS-P-F	18,0	17	29	590	420	655	60 - 75	separate	1400	160	100	2100
SAV-180NS-V12-Z   SAV-180NS-V12-P-F	18,0	18	30	740	420	655	80 - 100	separate	1400	160	100	2100
SAV-210NS-V12-Z   SAV-210NS-V12-P-F	21,0	22	35	740	420	655	80 - 100	separate	1400	160	100	2100
SAV-240NS-V12-Z   SAV-240NS-V12-P-F	24,0	26	42	740	420	655	80 - 100	separate	1400	160	100	2100



Savonia (NS)



Savonia Fibercoated (NS)

## Datos técnicos

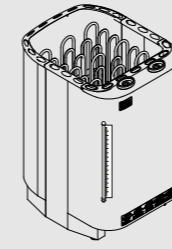

Savonia Combi

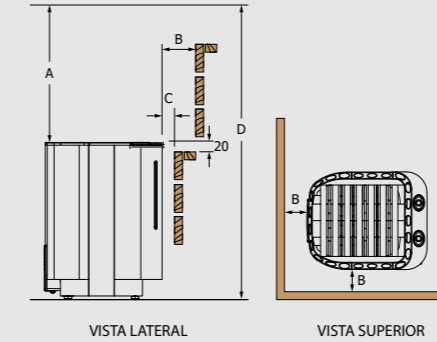

VISTA LATERAL VISTA SUPERIOR  
Distancias mínimas de seguridad



## Saunova/Innova (NS)

HEATER MODEL	kW HEATER	kW TANK	SAUNA ROOM		SIZE OF HEATER			STONES (kg)	CONTROL	MINIMUM SAFETY DISTANCES			
			MIN (m³)	MAX (m³)	LENGTH (mm)	WIDTH (mm)	HEIGHT (mm)			A	B	C	D
SAVC-90NS-Z   SAVC-90NS-P-F	9,0	1 x 2,0	8	14	510	420	655	40 - 50	separate	1200	110	50	1900
SAVC-105NS-Z   SAVC-105NS-P-F	10,5	1 x 2,0	9	15	510	420	655	40 - 50	separate	1200	120	60	1900
SAVC-120NS-Z   SAVC-120NS-P-F	12,0	1 x 2,0	10	18	510	420	655	40 - 50	separate	1400	130	70	2100
SAVC-150NS-Z   SAVC-150NS-P-F	15,0	2 x 2,0	13	23	715	420	655	60 - 75	separate	1400	160	100	2100
SAVC-180NS-Z   SAVC-180NS-P-F	18,0	2 x 2,0	17	29	715	420	655	60 - 75	separate	1400	160	100	2100



Savonia Combi (NS)



Savonia Combi Fibercoated (NS)

# Savonia Combi

Savonia Combi ofrece lo mejor de ambos mundos: el calor de la estufa Savonia y un vaporizador para generar más vapor y humedad.

También disponible con revestimiento de fibra seguro al tacto.

- » Rango de potencia: 9,0 – 18,0kW
- » Paneles de control disponibles: Saunova/Innova (NS)
- » Cubetas de aroma integradas
- » Depósito de agua con vaporizador de 1,0 kW o 2,0 kW
- » Patas ajustables
- » Opcional: llenado automático para el depósito de agua



## Estufas para sauna Línea PARED

Las estufas SAWO de montaje en pared destacan por ofrecer un rendimiento potente en un tamaño compacto. Para una mayor seguridad, la mayoría de nuestros modelos de pared están disponibles con revestimiento de fibra seguro al tacto, que ayuda a prevenir quemaduras accidentales.



Mini  
(NB)



Mini Fibercoated  
(NB)



Mini X  
(NS | NB)



Mini X  
Fibercoated  
(NS | NB)



Mini Combi  
(NS)



Mini Combi  
Fibercoated  
(NS)

### Mini

La estufa Mini puede instalarse en espacios reducidos gracias a su tamaño compacto y a sus mandos de control reversibles.

El modelo Mini también está disponible con revestimiento de fibra seguro al tacto.

- » Rango de potencia: 2,3 – 3,6kW
- » Paneles de control disponibles: Mandos integrados (NB)

### Mini X

Mini X es una estufa compacta diseñada para instalarse en la esquina de la cabina de sauna.

Está disponible con revestimiento de fibra seguro al tacto y es compatible con los controles Saunova o Innova (NS).

- » Rango de potencia: 2,3 – 3,6kW
- » Paneles de control disponibles: Saunova/Innova (NS), Mandos integrados (NB)

### Mini Combi

Mini Combi combina la experiencia de una sauna tradicional con un vaporizador que aporta un nivel adicional de humedad.

Está disponible con revestimiento de fibra seguro al tacto.

- » Rango de potencia: 3,0 – 3,6kW
- » Paneles de control disponibles: Saunova/Innova (NS)
- » Depósito de agua independiente con vaporizador de 1 kW
- » Cubetas de aroma integradas



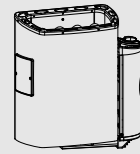

Mini

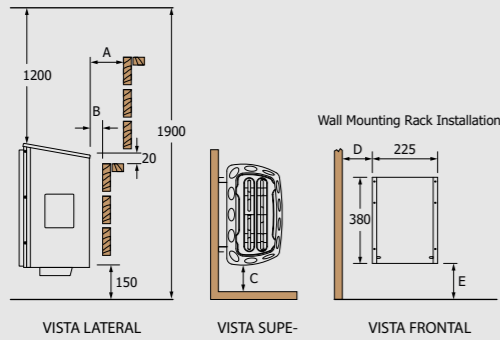

Distancias mínimas de seguridad

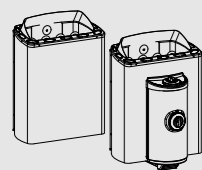

Mini X

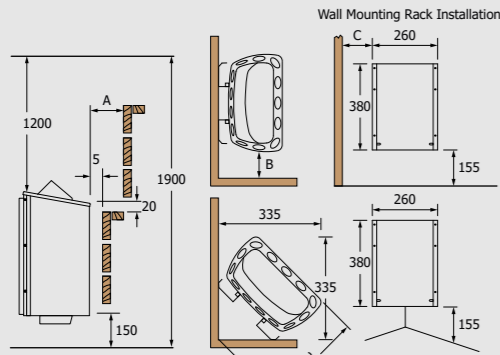

Distancias mínimas de seguridad

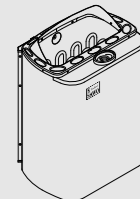

Mini Combi

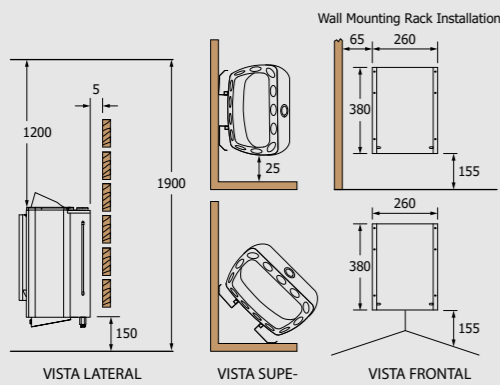

Distancias mínimas de seguridad

Mandos integrados (NB)

HEATER MODEL	kW	SAUNA ROOM (m³)		SIZE OF HEATER (mm)			STONES (kg)	CONTROL	MINIMUM SAFETY DISTANCES				
		MIN	MAX	LENGTH	WIDTH	HEIGHT			A	B	C	D	E
MN-23NB-Z   MN-23NB-P-F	2,3	1,3	2,5	*215	435	**455	11	built-in (8+4h)	100	20	100	140	155
MN-30NB-Z   MN-30NB-P-F	3,0	2	4	*215	435	**455	11	built-in (8+4h)	100	20	100	140	155
MN-36NB-Z   MN-36NB-P-F	3,6	3	6	*215	435	**455	11	built-in (8+4h)	100	20	100	140	155

\*Profundidad cuando se instala en la pared.  
\*\*Reflector not included.

Saunova/Innova (NS)

HEATER MODEL	kW	SAUNA ROOM (m³)		SIZE OF HEATER (mm)			STONES (kg)	CONTROL	MINIMUM SAFETY DISTANCES		
		MIN	MAX	LENGTH	WIDTH	HEIGHT			A	B	C
MX-23NS-Z   MX-23NS-P-F	2,3	1,3	2,5	*310	330	485	8 - 11	separate	30	20	60
MX-30NS-Z   MX-30NS-P-F	3,0	2	4	*310	330	485	8 - 11	separate	35	25	65
MX-36NS-Z   MX-36NS-P-F	3,6	3	6	*310	330	485	8 - 11	separate	40	25	65

Mandos integrados (NB)

HEATER MODEL	kW	SAUNA ROOM (m³)		SIZE OF HEATER (mm)			STONES (kg)	CONTROL	MINIMUM SAFETY DISTANCES		
		MIN	MAX	LENGTH	WIDTH	HEIGHT			A	B	C
MX-23NB-Z   MX-23NB-P-F	2,3	1,3	2,5	*310	330	485	8 - 11	built-in (8+4h)	30	20	60
MX-30NB-Z   MX-30NB-P-F	3,0	2	4	*310	330	485	8 - 11	built-in (8+4h)	35	25	65
MX-36NB-Z   MX-36NB-P-F	3,6	3	6	*310	330	485	8 - 11	built-in (8+4h)	40	25	65

\*Wall mounted/corner mounted.

Saunova/Innova (NS)

HEATER MODEL	kW HEATER	kW TANK	SAUNA ROOM (m³)		SIZE OF HEATER (mm)			STONES (kg)	CONTROL
			MIN	MAX	LENGTH	WIDTH	HEIGHT		
MNC-30NS-Z	3,0	1 x 1,0	2	4	**330	260	*500	8 - 10,5	separate
MNC-30NS-P-F	3,0	1 x 1,0	2	4	**330	260	*500	8 - 10,5	separate
MNC-36NS-Z	3,6	1 x 1,0	3	6	**330	260	*500	8 - 10,5	separate
MNC-36NS-P-F	3,6	1 x 1,0	3	6	**330	260	*500	8 - 10,5	separate

\*Profundidad cuando se instala en la pared.  
\*\*Reflector not included.



# Scandia

Scandia es un modelo clásico entre las estufas de sauna. Su diseño tradicional ofrece la experiencia finlandesa de sauna de siempre.

Está disponible con revestimiento de fibra seguro al tacto y es compatible con los controles SAWO Sense, Saunova o Innova (NS).

- » Rango de potencia: 4,5 – 9,0kW
- » Paneles de control disponibles: Saunova/Innova (NS), Mandos integrados (NB)

Datos técnicos

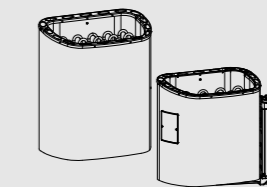

Scandia

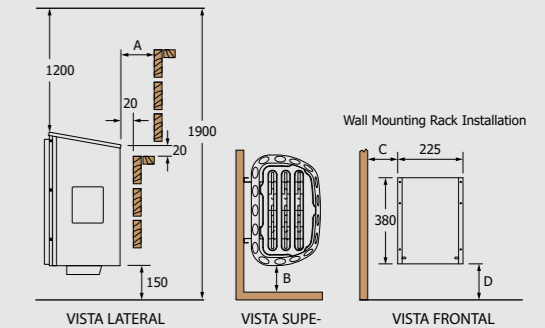

Distancias mínimas de seguridad

Saunova/Innova (NS)

HEATER MODEL	kW	SAUNA ROOM (m³)		SIZE OF HEATER (mm)			STONES (kg)	CONTROL	MINIMUM SAFETY DISTANCES			
		MIN	MAX	LENGTH	WIDTH	HEIGHT			A	B	C	D
SCA-45NS-Z-C   SCA-45NS-P-F-C	4,5	3	6	*290	410	**515	18 - 22	separate	100	100	185	155
SCA-60NS-Z-C   SCA-60NS-P-F-C	6,0	5	9	*290	410	**515	18 - 22	separate	100	100	185	155
SCA-80NS-Z-C   SCA-80NS-P-F-C	8,0	7	13	*290	410	**585	19 - 23	separate	100	100	185	235
SCA-90NS-Z-C   SCA-90NS-P-F-C	9,0	8	14	*290	410	**585	19 - 23	separate	100	100	185	235

Mandos integrados (NB)

HEATER MODEL	kW	SAUNA ROOM (m³)		SIZE OF HEATER (mm)			STONES (kg)	CONTROL	MINIMUM SAFETY DISTANCES			
		MIN	MAX	LENGTH	WIDTH	HEIGHT			A	B	C	D
SCA-45NB-Z-C   SCA-45NB-P-F-C	4,5	3	6	*290	515	**515	18 - 22	built-in (8+4h)	100	100	185	155
SCA-60NB-Z-C   SCA-60NB-P-F-C	6,0	5	9	*290	515	**515	18 - 22	built-in (8+4h)	100	100	185	155
SCA-80NB-Z-C   SCA-80NB-P-F-C	8,0	7	13	*290	515	**585	19 - 23	built-in (8+4h)	100	100	185	235
SCA-90NB-Z-C   SCA-90NB-P-F-C	9,0	8	14	*290	515	**585	19 - 23	built-in (8+4h)	100	100	185	235

\*Profundidad cuando se instala en la pared.  
\*\*Reflector not included.

# Scandia Combi

La estufa Scandia Combi incorpora un vaporizador para aportar un mayor nivel de humedad, así como una cubeta para aromas. Está disponible con revestimiento de fibra seguro al tacto y es compatible con SAWO Sense, Saunova o Innova (NS).

- » Rango de potencia: 6,0 – 9,0kW
- » Paneles de control disponibles: Saunova/Innova (NS)
- » Depósito de agua con vaporizador de 1,0 kW o 2,0 kW
- » Cubetas de aroma integradas



# Krios

Krios ofrece la mejor stone containment de piedras Krios mayor capacidad, lo que permite generar un calor más intenso y con un nivel de humedad superior.

La estufa Krios es compatible con los controles SAWO Sense, Saunova (Ni2, NS) y Innova (NS).

- » Rango de potencia: 4,5 – 9,0kW
- » Paneles de control disponibles: Saunova (Ni2), Saunova/Innova (NS), Mandos integrados (NB)
- » Wall mounted
- » Carcasa: Acero inoxidable
- » Heat reflector included
- » Mandos integrados control unit can be attached to the left, right, or front of the heater
- » Can fit 50kg of stones



## Datos técnicos

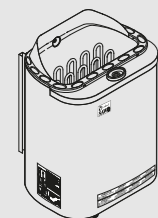

Scandia Combi

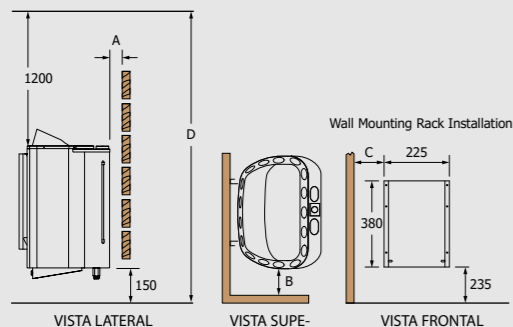

Distancias mínimas de seguridad

## Saunova/Innova (NS)

HEATER MODEL	kW HEATER	kW TANK	SAUNA ROOM		SIZE OF HEATER			STONES (kg)	CONTROL	MINIMUM SAFETY DISTANCES			
			MIN (m³)	MAX	LENGTH (mm)	WIDTH (mm)	HEIGHT (mm)			A	B	C	D
SCAC-60NS-Z-C   SCAC-60NS-P-F-C	6,0	1 x 1,0	5	9	*365	410	595	18-22	separate	5	50	135	1900
SCAC-80NS-Z-C   SCAC-80NS-P-F-C	8,0	1 x 2,0	7	13	*365	410	595	18-22	separate	5	50	135	1900
SCAC-90NS-Z-C   SCAC-90NS-P-F-C	9,0	1 x 2,0	8	14	*365	410	595	18-22	separate	5	50	135	1900

\*Profundidad cuando se instala en la pared.



Scandia Combi (NS)



Scandia Combi Fibercoated (NS)



Krios (Ni2)



Krios (NS)



Krios (NB)



### Datos técnicos

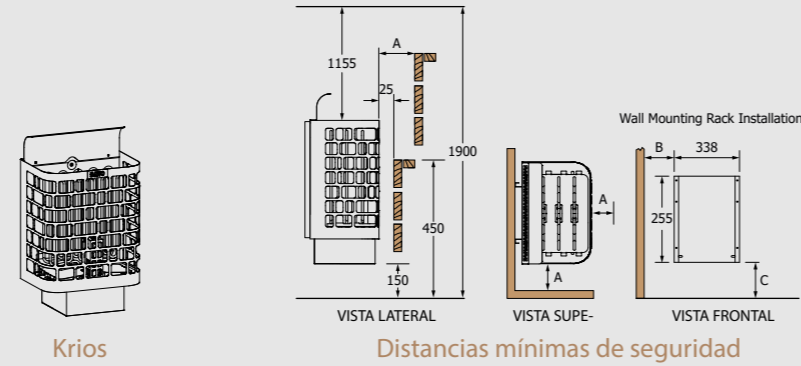

### Saunova (Ni2)

HEATER MODEL	kW	SAUNA ROOM		SIZE OF HEATER			STONES (kg)	CONTROL	MINIMUM SAFETY DISTANCES		
		MIN (m³)	MAX (m³)	LENGTH (mm)	WIDTH (mm)	HEIGHT (mm)			A	B	C
KRI-45Ni2-P-C	4,5	3	6	*290	390	**600	40	Saunova 2.0	50	75	345
KRI-60Ni2-P-C	6,0	5	8	*290	390	**600	40	Saunova 2.0	80	105	345
KRI-80Ni2-P-C	8,0	7	13	*290	390	**670	50	Saunova 2.0	100	125	415
KRI-90Ni2-P-C	9,0	8	14	*290	390	**670	50	Saunova 2.0	100	125	415

### Saunova/Innova (NS)

HEATER MODEL	kW	SAUNA ROOM		SIZE OF HEATER			STONES (kg)	CONTROL	MINIMUM SAFETY DISTANCES		
		MIN (m³)	MAX (m³)	LENGTH (mm)	WIDTH (mm)	HEIGHT (mm)			A	B	C
KRI-45NS-P-C	4,5	3	6	*290	390	**580	40	Innova	50	75	320
KRI-60NS-P-C	6,0	5	8	*290	390	**580	40	Innova	80	105	320
KRI-80NS-P-C	8,0	7	13	*290	390	**650	50	Innova	100	125	390
KRI-90NS-P-C	9,0	8	14	*290	390	**650	50	Innova	100	125	390

### Mandos integrados (NB)

HEATER MODEL	kW	SAUNA ROOM		SIZE OF HEATER			STONES (kg)	CONTROL	MINIMUM SAFETY DISTANCES		
		MIN (m³)	MAX (m³)	LENGTH (mm)	WIDTH (mm)	HEIGHT (mm)			A	B	C
KRI-45NB-P-C	4,5	3	6	*290	390	**580	40	Built-in	50	75	320
KRI-60NB-P-C	6,0	5	8	*290	390	**580	40	Built-in	80	105	320
KRI-80NB-P-C	8,0	7	13	*290	390	**650	50	Built-in	100	125	390
KRI-90NB-P-C	9,0	8	14	*290	390	**650	50	Built-in	100	125	390

\*Profundidad cuando se instala en la pared.  
\*\*Height with reflector.



### Datos técnicos

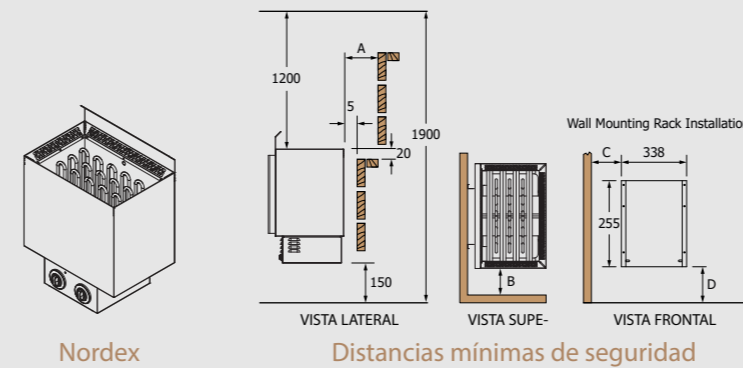

### Saunova (Ni2)

HEATER MODEL	kW	SAUNA ROOM		SIZE OF HEATER			STONES (kg)	CONTROL	MINIMUM SAFETY DISTANCES			
		MIN (m³)	MAX (m³)	LENGTH (mm)	WIDTH (mm)	HEIGHT (mm)			A	B	C	D
NRN-45Ni2-Z-C   NRN-45Ni2-BL-Z-C	4,5	3	6	*295	400	**515	22	Saunova 2.0	50	50	130	270
NRN-60Ni2-Z-C   NRN-60Ni2-BL-Z-C	6,0	5	9	*295	400	**515	22	Saunova 2.0	50	50	130	270
NRN-80Ni2-Z-C   NRN-80Ni2-BL-Z-C	8,0	7	13	*295	400	**590	22	Saunova 2.0	80	80	160	330
NRN-90Ni2-Z-C   NRN-90Ni2-BL-Z-C	9,0	8	14	*295	400	**590	22	Saunova 2.0	80	80	160	330

### Mandos integrados (NB) and Saunova/Innova (NS)

HEATER MODEL	kW	SAUNA ROOM		SIZE OF HEATER			STONES (kg)	CONTROL	MINIMUM SAFETY DISTANCES			
		MIN (m³)	MAX (m³)	WIDTH (mm)	DEPTH (mm)	HEIGHT (mm)			A	B	C	D
NRN-45NB/NS-Z-C   NRN-45NB/NS-BL-Z-C	4,5	3	6	*295	400	**515	18-22	built-in (8+4h)	50	50	80	320
NRN-60NB/NS-Z-C   NRN-60NB/NS-BL-Z-C	6,0	5	9	*295	400	**515	18-22	built-in (8+4h)	50	50	80	320
NRN-80NB/NS-Z-C   NRN-80NB/NS-BL-Z-C	8,0	7	13	*295	400	**590	18-22	built-in (8+4h)	80	80	110	395
NRN-90NB/NS-Z-C   NRN-90NB/NS-BL-Z-C	9,0	8	14	*295	400	**590	18-22	built-in (8+4h)	80	80	110	395

\*Profundidad cuando se instala en la pared.  
\*\*Height with reflector.



# Nordex

La estufa Nordex está disponible con carcasa de acero inoxidable o carcasa metálica en color negro, y es compatible con los controles externos SAWO Sense, Saunova (Ni2/NS) e Innova (NS).

- » Rango de potencia: 4,5 – 9,0kW
- » Paneles de control disponibles: Saunova (Ni2), Saunova/Innova (NS), Mandos integrados (NB)



### Accesorios para estufa (opcionales)



Madera  
Cedro (D) y Aspen (A)

MODEL	SIZE OF GUARD RAIL	LENGTH (mm)	WIDTH (mm)	HEIGHT (mm)
KRI-GUARD-W-D	385	620	90	
KRI-GUARD-W-A	385	620	90	

### Heater Accessories (Opcional)



MODEL	SIZE OF GUARD RAIL	LENGTH (mm)	WIDTH (mm)	HEIGHT (mm)
NRN-GUARD-W-D	100	465	75	
NRN-GUARD-W-A	100	465	75	

# Nordex Combi

Nordex Combi añade humedad al calor gracias a su vaporizador integrado.

Está disponible con carcasa de acero inoxidable o carcasa metálica en color negro, y es compatible con los controles SAWO Sense, Saunova e Innova (NS).

- » Rango de potencia: 6,0 – 9,0kW
- » Paneles de control disponibles: Saunova/Innova (NS)
- » Separate water tank with 0,8kW or 2,0kW Generador de Vapor
- » Cubetas de aroma integradas

### Saunova/Innova (NS)

HEATER MODEL	kW HEATER	kW TANK	SAUNA ROOM MAX (m <sup>3</sup> )	SIZE OF HEATER LENGTH (mm)	WIDTH (mm)	HEIGHT (mm)	STONES (kg)	CONTROL
NRNC-60NS-Z-C   NRNC-60NS-BL-Z-C	6,0	1 x 0,8	5 9	**385	400	*610	22	Innova
NRNC-80NS-Z-C   NRNC-80NS-BL-Z-C	8,0	1 x 2,0	7 13	**385	400	*610	22	Innova
NRNC-90NS-Z-C   NRNC-90NS-BL-Z-C	9,0	1 x 2,0	8 14	**385	400	*610	22	Innova

\*\*Profundidad cuando se instala en la pared.  
\*Height with reflector.



Nordex Combi (NS)



Nordex Combi Black (NS)



### Datos técnicos

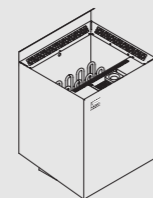

Nordex Combi

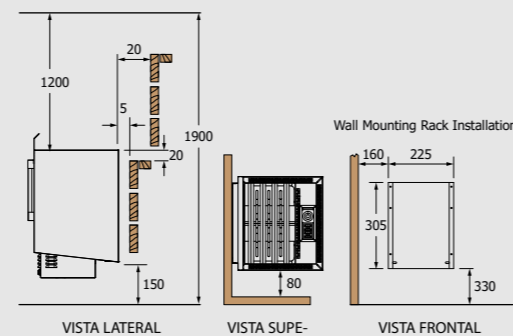

Distancias mínimas de seguridad

# Nordex Mini

La ultra-compacta Nordex Mini puede montarse en pared tanto en posición recta como en esquina.

Está disponible con carcasa de acero inoxidable o carcasa metálica en color negro, y es compatible con los controles externos SAWO Sense, Saunova (Ni2, NS) e Innova (NS).

- » Rango de potencia: 2,3 – 3,6kW
- » Paneles de control disponibles: SAWO Sense, Saunova (Ni2), Saunova/Innova (NS), Mandos integrados (NB)

! Para más información técnica, consulte la página 61.



Nordex Mini (Ni2)

Nordex Mini Black (Ni2)



Nordex Mini (NS)

Nordex Mini Black (NS)



Nordex Mini (NB)

Nordex Mini Black (NB)

# Nordex Mini Combi

El ultra-compacto Nordex Mini Combi añade humedad al calor gracias a su vaporizador integrado.

Está disponible con carcasa de acero inoxidable o carcasa metálica en color negro, y es compatible con los controles externos SAWO Sense, Saunova (NS) e Innova (NS).

- » Rango de potencia: 3,0 – 3,6kW
- » Paneles de control disponibles: Saunova/Innova (NS)
- » Depósito de agua con vaporizador de 0,8 kW
- » Cubetas de aroma integradas

! Para más información técnica, consulte la página 61.



Nordex Mini Combi (NS)



Nordex Mini Combi Black (NS)



## Datos técnicos

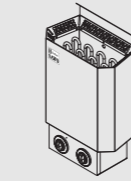

Nordex Mini

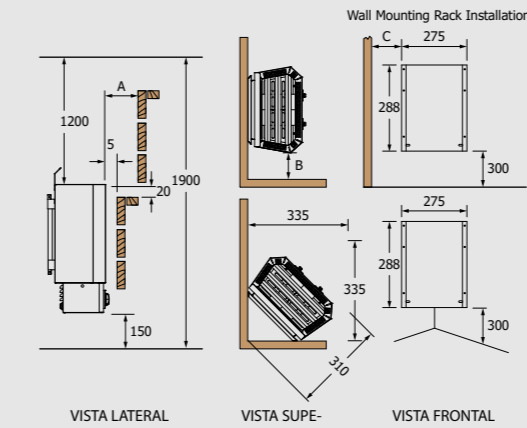

Distancias mínimas de seguridad

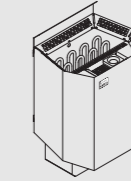

Nordex Mini Combi

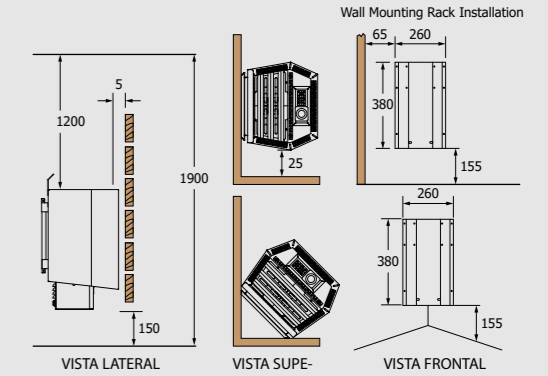

Distancias mínimas de seguridad

## Saunova (Ni2)

HEATER MODEL	kW	SAUNA ROOM		SIZE OF HEATER			STONES (KG)	CONTROL	MINIMUM SAFETY DISTANCES		
		MIN (m³)	MAX	LENGTH	WIDTH (mm)	HEIGHT			A	B	C
NRM-23Ni2-Z-C	2,3	1,3	2,5	*200	340	**500	8 - 11	Saunova	50	30	85
NRM-30Ni2-Z-C	3,0	2	4	*200	340	**500	8 - 11	Saunova	50	30	85
NRM-36Ni2-Z-C	3,6	3	6	*200	340	**500	8 - 11	Saunova	50	30	85

\*Profundidad cuando se instala en la pared.  
\*\*Height with reflector.

## Saunova/Innova (NS)

HEATER MODEL	kW HEATER	kW TANK	SAUNA ROOM		SIZE OF HEATER			STONES (KG)	CONTROL
			MIN (m³)	MAX	LENGTH	WIDTH (mm)	HEIGHT		
NRMC-30NS-Z	3,0	1 x 0,8	2	4	*300	345	**525	8 - 10,5	separate
NRMC-36NS-Z	3,6	1 x 0,8	3	6	*300	345	**525	8 - 10,5	separate

\*Profundidad cuando se instala en la pared.  
\*\*Height with reflector.

## Saunova/Innova (NS) and Mandos integrados (NB)

HEATER MODEL	kW	SAUNA ROOM		SIZE OF HEATER			STONES (KG)	CONTROL	MINIMUM SAFETY DISTANCES		
		MIN (m³)	MAX	LENGTH	WIDTH (mm)	HEIGHT			A	B	C
NRM-23NS-Z	2,3	1,3	2,5	*200	340	**500	8 - 11	separate	30 50	20 30	60 85
NRM-23NS-Z	3,0	2	4	*200	340	**500	8 - 11	separate	35 50	25 30	65 85
NRM-36NS-Z	3,6	3	6	*200	340	**500	8 - 11	separate	40 50	25 30	65 85
NRM-23NB-Z	2,3	1,3	2,5	*200	340	**500	8 - 11	built-in (8+4h)	30 50	20 30	60 85
NRM-30NB-Z	3,0	2	4	*200	340	**500	8 - 11	built-in (8+4h)	35 50	25 30	65 85
NRM-36NB-Z	3,6	3	6	*200	340	**500	8 - 11	built-in (8+4h)	40 50	25 30	65 85

\*Profundidad cuando se instala en la pared.  
\*\*Height with reflector.



# Scandifire

Scandifire, diseñada por Stefan Lindfors, aporta al clásico modelo Scandia un aspecto más atrevido y distintivo gracias a su patrón Junglefir.

Este diseño se combina con un revestimiento de fibra seguro al tacto, y la estufa es compatible con los controles SAWO Sense, Saunova e Innova (NS).

! Para más información técnica, consulte la página 64.

## Scandifire

- » Rango de potencia: 4,5 – 9,0kW
- » Paneles de control disponibles: Saunova/ Innova (NS), Mandos integrados (NB)
- » Carcasa: Fibercoated with Junglefir pattern
- » Wall mounted
- » Can fit 22kg of stones
- » Mandos integrados models: Control knobs are with light indicator
- » Coating shields the heater from moisture and high temperature



Scandifire Red (NB)



Scandifire Black (NB)



Scandifire Red (NS)



Scandifire Black (NS)



# Minidragon

Minidragon es la estufa más compacta diseñada por Stefan Lindfors, creada para aportar estilo incluso en los espacios más reducidos.

La estufa incluye revestimiento de fibra seguro al tacto y es compatible con los controles SAWO Sense, Saunova e Innova (NS).

! Para más información técnica, consulte la página 64.



Minidragon Red (NB)



Minidragon Black (NB)



Minidragon Red (NS)



Minidragon Black (NS)

## Minidragon

- » Rango de potencia: 2,3 – 3,6kW
- » Paneles de control disponibles: Saunova/ Innova (NS), Mandos integrados (NB)
- » Carcasa: Fibercoated with Junglefir pattern
- » Wall mounted
- » Can fit 11kg of stones
- » Mandos integrados models: Control knobs are with light indicator

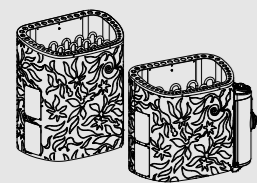

Scandifire

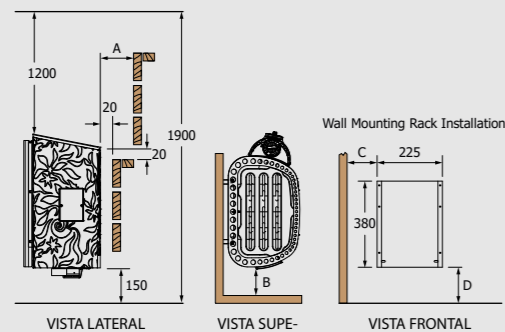

Distancias mínimas de seguridad



Minidragon

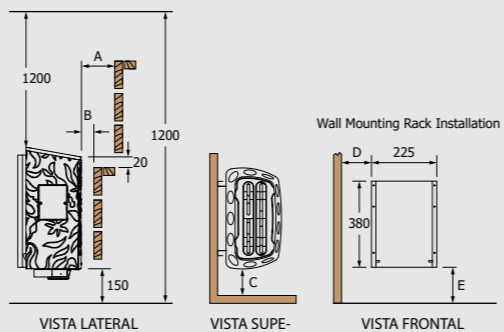

Distancias mínimas de seguridad

Saunova/Innova (NS)

HEATER MODEL	kW	SAUNA ROOM		SIZE OF HEATER			STONES (kg)	CONTROL	MINIMUM SAFETY DISTANCES			
		MIN (m³)	MAX	LENGTH	WIDTH (mm)	HEIGHT			A	B	C	D
SCA-45NS-DRF-P-C   SCA-45NS-DRF-BL-P-C	4,5	3	6	*290	410	455	18 - 22	separate	60	50	135	155
SCA-60NS-DRF-P-C   SCA-60NS-DRF-BL-P-C	6,0	5	9	*290	410	455	18 - 22	separate	60	50	135	155
SCA-80NS-DRF-P-C   SCA-80NS-DRF-BL-P-C	8,0	7	13	*290	410	525	18 - 22	separate	60	50	135	235
SCA-90NS-DRF-P-C   SCA-90NS-DRF-BL-P-C	9,0	8	14	*290	410	525	18 - 22	separate	60	50	135	235

Mandos integrados (NB)

HEATER MODEL	kW	SAUNA ROOM		SIZE OF HEATER			STONES (kg)	CONTROL	MINIMUM SAFETY DISTANCES				
		MIN (m³)	MAX	LENGTH	WIDTH (mm)	HEIGHT			A	B	C	D	E
SCA-45NB-DRF-P-C   SCA-45NB-DRF-BL-P-C	4,5	3	6	*290	515	455	18 - 22	built-in (8+4h)	50	50	185	155	
SCA-60NB-DRF-P-C   SCA-60NB-DRF-BL-P-C	6,0	5	9	*290	515	455	18 - 22	built-in (8+4h)	50	50	185	155	
SCA-80NB-DRF-P-C   SCA-80NB-DRF-BL-P-C	8,0	7	13	*290	515	525	18 - 22	built-in (8+4h)	100	100	185	235	
SCA-90NB-DRF-P-C   SCA-90NB-DRF-BL-P-C	9,0	8	14	*290	515	525	18 - 22	built-in (8+4h)	100	100	185	235	

\*Profundidad cuando se instala en la pared.

Saunova/Innova (NS)

HEATER MODEL	kW	SAUNA ROOM		SIZE OF HEATER			STONES (kg)	CONTROL	MINIMUM SAFETY DISTANCES				
		MIN (m³)	MAX	LENGTH	WIDTH (mm)	HEIGHT			A	B	C	D	E
MN-23NS-DRF-P   MN-23NS-DRF-BL-P	2,3	1,3	2,5	*215	435	455	8 - 11	separate	50	20	40	90	155
MN-30NS-DRF-P   MN-30NS-DRF-BL-P	3,0	2	4	*215	435	455	8 - 11	separate	60	20	50	90	155
MN-36NS-DRF-P   MN-36NS-DRF-BL-P	3,6	3	6	*215	435	455	8 - 11	separate	90	20	50	90	155

Mandos integrados (NB)

HEATER MODEL	kW	SAUNA ROOM		SIZE OF HEATER			STONES (kg)	CONTROL	MINIMUM SAFETY DISTANCES				
		MIN (m³)	MAX	LENGTH	WIDTH (mm)	HEIGHT			A	B	C	D	E
MN-23NB-DRF-P   MN-23NB-DRF-BL-P	2,3	1,3	2,5	*215	435	455	8 - 11	built-in (8+4h)	50	20	40	140	155
MN-30NB-DRF-P   MN-30NB-DRF-BL-P	3,0	2	4	*215	435	455	8 - 11	built-in (8+4h)	60	20	50	140	155
MN-36NB-DRF-P   MN-36NB-DRF-BL-P	3,6	3	6	*215	435	455	8 - 11	built-in (8+4h)	90	20	80	140	155

\*Profundidad cuando se instala en la pared.



# Estufas para sauna

## Línea PIEDRA

Fabricadas en piedra de jabón finlandesa, las estufas de piedra de SAWO ofrecen unas propiedades excepcionales de almacenamiento y transmisión del calor.

Su calor suave proporciona una experiencia de sauna constante, envolvente y de larga duración.

# Nimbus

La llamativa estufa Nimbus incorpora una carcasa de piedra de jabón, lo que garantiza un calor duradero y estable durante toda la sesión.

Nimbus es compatible con los controles SAWO Sense, Saunova e Innova (NS).

- » Rango de potencia: 9,0 – 24,0kW
- » Paneles de control disponibles: Saunova/Innova (NS)



## Saunova/Innova (NS)

HEATER MODEL	kW	SAUNA ROOM (m³)		SIZE OF HEATER (mm)			STONES SOAPSTONES (kg)		CONTROL	MINIMUM SAFETY DISTANCES			
		MIN	MAX	LENGTH	WIDTH	HEIGHT				A	B	C	D
NIM-90NS-P	9,0	8	14	520	470	690	40-50	80	separate	1200	110	50	1900
NIM-105NS-P	10,5	9	15	520	470	690	40-50	80	separate	1200	120	60	1900
NIM-120NS-P	12,0	10	18	520	470	690	40-50	80	separate	1400	130	70	2100
NIM-150NS-P	15,0	13	23	660	470	690	60-75	100	separate	1400	160	100	2100
NIM-180NS-P	18,0	17	29	660	470	690	60-75	100	separate	1400	160	100	2100
NIM-180NS-V12-P	18,0	18	30	820	470	690	80-100	120	separate	1400	160	100	2100
NIM-210NS-V12-P	21,0	22	35	820	470	690	80-100	120	separate	1400	160	100	2100
NIM-240NS-V12-P	24,0	26	42	820	470	690	80-100	120	separate	1400	160	100	2100



Nimbus (NS)



## Datos técnicos

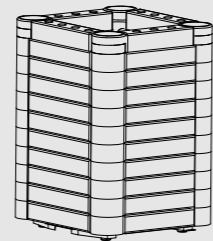

Nimbus

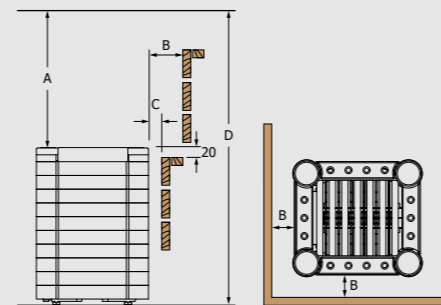

VISTA FRONTAL VISTA SUPERIOR Distancias mínimas de seguridad

## Datos técnicos

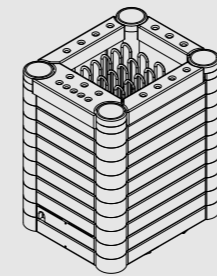

Nimbus Combi

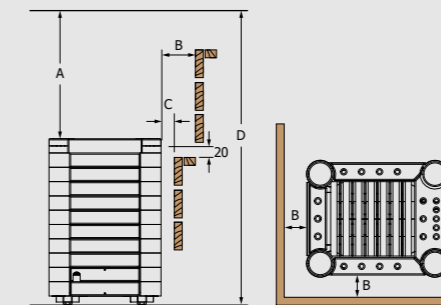

VISTA FRONTAL VISTA SUPERIOR Distancias mínimas de seguridad

# Nimbus Combi

Nimbus Combi incrementa la producción de vapor gracias a su vaporizador, logrando un equilibrio perfecto entre calor y humedad.

La estufa es compatible con los controles SAWO Sense, Saunova e Innova (NS).

- » Rango de potencia: 9,0 – 18,0kW
- » Paneles de control disponibles: Saunova/Innova (NS)
- » Cubetas de aroma integradas
- » Opcional: auto-refill feature for automatically refilling the water tank



## Saunova/Innova (NS)

HEATER MODEL	kW HEATER	kW TANK	SAUNA ROOM (m³)		SIZE OF HEATER (mm)			STONES SOAPSTONES (kg)		CONTROL	MINIMUM SAFETY DISTANCES			
			MIN	MAX	LENGTH	WIDTH	HEIGHT				A	B	C	D
NIMC-90NS-P	9,0	1 x 2,0	8	14	575	470	690	40-50	90	separate	1200	50	30	1900
NIMC-105NS-P	10,5	1 x 2,0	9	15	575	470	690	40-50	90	separate	1200	50	30	1900
NIMC-120NS-P	12,0	1 x 2,0	10	18	575	470	690	40-50	90	separate	1400	130	70	2100
NIMC-150NS-P	15,0	2 x 2,0	13	23	775	470	690	60-75	120	separate	1400	160	100	2100
NIMC-180NS-P	18,0	2 x 2,0	17	29	775	470	690	60-75	120	separate	1400	160	100	2100



Nimbus Combi (NS)



## Datos técnicos



Cumulus

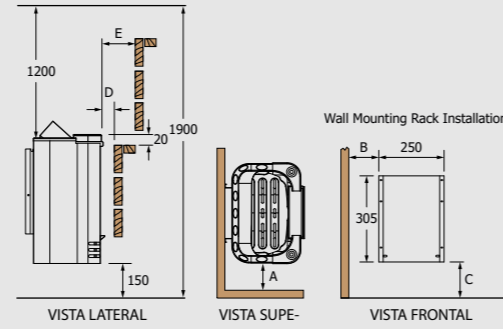

Distancias mínimas de seguridad

# Cumulus

Cumulus es una estufa elegante y montada en pared con un frontal decorativo de piedra de jabón finlandesa. Permite añadir aromaterapia a la experiencia de sauna mediante las cubetas para esencias integradas en la parte superior de la estufa.

- » Rango de potencia: 4,5 – 9,0kW
- » Paneles de control disponibles: Saunova (Ni2), Saunova/Innova (NS), Mandos integrados (NB)
- » Cubetas de aroma integradas



Cumulus (Ni2)

Cumulus (NS)

Cumulus (NB)

## Saunova (Ni2)

HEATER MODEL	kW	SAUNA ROOM		SIZE OF HEATER			STONES	SOAPSTONES (kg)	CONTROL	MINIMUM SAFETY DISTANCES				
		MIN (m²)	MAX (m²)	LENGTH (mm)	WIDTH (mm)	HEIGHT (mm)				A	B	C	D	E
CML-45Ni2-P-C	4,5	3	6	*300	420	500	18	22	Saunova	50	130	245	20	50
CML-60Ni2-P-C	6,0	5	9	*300	420	500	18	22	Saunova	50	130	245	20	50
CML-80Ni2-P-C	8,0	7	13	*300	420	590	18	22	Saunova	60	140	330	30	60
CML-90Ni2-P-C	9,0	8	14	*300	420	590	18	22	Saunova	60	140	330	30	60

## Saunova/Innova (NS)

HEATER MODEL	kW	SAUNA ROOM		SIZE OF HEATER			STONES	SOAPSTONES (kg)	CONTROL	MINIMUM SAFETY DISTANCES				
		MIN (m²)	MAX (m²)	LENGTH (mm)	WIDTH (mm)	HEIGHT (mm)				A	B	C	D	E
CML-45NS-P-C	4,5	3	6	*300	420	500	18	22	separate	50	130	245	20	50
CML-60NS-P-C	6,0	5	9	*300	420	500	18	22	separate	50	130	245	20	50
CML-80NS-P-C	8,0	7	13	*300	420	590	18	22	separate	60	140	330	30	60
CML-90NS-P-C	9,0	8	14	*300	420	590	18	22	separate	60	140	330	30	60

## Mandos integrados (NB)

HEATER MODEL	kW	SAUNA ROOM		SIZE OF HEATER			STONES	SOAPSTONES (kg)	CONTROL	MINIMUM SAFETY DISTANCES				
		MIN (m²)	MAX (m²)	LENGTH (mm)	WIDTH (mm)	HEIGHT (mm)				A	B	C	D	E
CML-45NB-P-C	4,5	3	6	*300	420	500	18	22	built-in (8+4h)	50	130	245	20	50
CML-60NB-P-C	6,0	5	9	*300	420	500	18	22	built-in (8+4h)	50	130	245	20	50
CML-80NB-P-C	8,0	7	13	*300	420	590	18	22	built-in (8+4h)	60	140	330	30	60
CML-90NB-P-C	9,0	8	14	*300	420	590	18	22	built-in (8+4h)	60	140	330	30	60

\*Profundidad cuando se instala en la pared.

# ACCESORIOS Para estufas

## Safety Switch

(for wall-mounted, tower, and floor heaters)



Safety Switch

código: HP20-001

The safety switch will turn the heater off if a towel or similar object is placed on top. The heater will not turn off if it comes into contact with a foreign object or if the object enters the safety distances around the heater. (Follows standard SFS-EN60335-2-53, sec. 19.10)

## Emergency Stop



Emergency Stop Button Switch

código: ESTOP

The push button allows the sauna heater to be switched off. Package includes extra overheat fuse.

## Cozy Tank

- » Water storage that adds instant steam when heater is hot
- » Refillable water via top cover holes
- » Thick Acero inoxidable metal
- » Carved Piedra de jabón top cover
- » Available in 3 designs
- » Scent pockets for sauna aroma



Cozy Tank 0,3L

código: HP01-090

Cylindrical Sauna Humidifier (Water Volume 0,3L)



Cozy Tank 0,6L

código: HP01-070

Cylindrical Sauna Humidifier (Water Volume 0,6L)

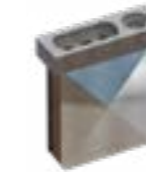

Cozy Tank 1,3L

código: HP01-071

Rectangular Sauna Humidifier (Water Volume 1,3L)

WATER VOLUME	HEATERS
0,3 Liter	Tower (Round, Wall, Corner), Aries (Round, Wall, Corner), Phoenix, Orion, Cubos
0,6 Liter	Tower (Round, Wall, Corner), Aries (Round, Wall, Corner), Phoenix, Orion, Cubos
1,3 Liter	Taurus, Mini, Mini X, Scandia, Savonia, Nordex Mini, Nordex, Nordex Floor, Nimbus, Cumulus



## Sauna Stones



Sauna Stones Rounded (20kg)

código: R-980  
R-981

tamaño: 3-10cm  
8-15cm



Decorative Sauna Stones White Quartz Rounded (10kg)

código: R-982  
R-983

tamaño: 3-10cm  
8-15cm

# Controladores de SAUNA

Los momentos de bienestar están a solo unos clics de distancia.



## SAWO Sense



El SAWO Sense lleva el control inteligente de la sauna al siguiente nivel gracias a su elegante interfaz táctil.

Permite gestionar de forma sencilla la temperatura, la iluminación y otras funciones de la sauna, tanto desde su pantalla intuitiva como a través de la app SAWO, gracias a su conectividad Wi-Fi integrada.

Con monitorización en tiempo real y acceso remoto, los usuarios pueden personalizar y controlar sus sesiones de sauna en cualquier momento y desde cualquier lugar.

Diseñado para estufas de hasta 9,0 kW, el sistema puede ampliarse hasta 18,0 kW mediante una unidad de contactor, ofreciendo así la máxima flexibilidad para



SAWO Sense Metal  
código: SEN-UI-SST



SAWO Sense Black  
código: SEN-UI-BL



SAWO Sense Pináceas  
código: SEN-UI-P



SAWO Sense White  
código: SEN-UI-WH

# Saunova 2.0 PLUS

Nuestra nueva unidad de control inteligente, Saunova 2.0 PLUS, ofrece al usuario una libertad de uso aún mayor. La unidad de control incluye conectividad Wi-Fi, lo que permite manejarla a través de la app de SAWO.

La aplicación ofrece una experiencia de sauna más personalizada y el control remoto de múltiples funciones, como la temperatura o la iluminación. Gracias a la monitorización en tiempo real, el usuario puede ver instantáneamente la temperatura actual de la sauna y la duración de la sesión.

La Saunova 2.0 PLUS incorpora una interfaz de usuario intuitiva, que puede instalarse tanto dentro como fuera de la cabina de sauna.

Diseñada para estufas de hasta 9,0 kW, la Saunova 2.0 PLUS puede ampliarse hasta 18,0 kW mediante una unidad de contactor.



## Saunova 2.0 PLUS (SAU-UI-V2-PLUS)

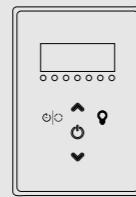

- » Remote control: Set schedule and control the heater from anywhere and any distance.
- » Intuitive interface: Use the app and controls with ease, thanks to our streamlined UI/UX design.
- » Integrated controls: All control settings can be managed through one platform: the smart control or the mobile app.
- » Real-time monitoring: Get instant access to the current sauna temperature and session time.
- » Safety: Heaters automatically turn off when the timer reaches zero.

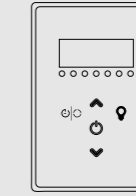

## Saunova 2.0 (SAU-UI-V2)

- » Dimensions: (L) 37 x (W) 104 x (H) 147mm
- » Direct control for all Ni2 heaters, for NS Heaters 2,3 – 9,0kW add Saunova 2.0 Power Controller, for 9,0 – 18,0kW add Saunova 2.0 Contactor Unit
- » Power Controller
- » More than 9,0kW needs a Contactor
- » Smart heater control feature for automatic heat control
- » Opcional Fan and Combi features

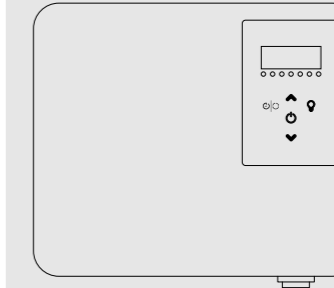

Saunova 2.0 Power Controller (SAU-PC-V2)

## Saunova 2.0 Mandos integrados (SAU-B-V2)

- » Dimensions: (L) 80 x (W) 320 x (H) 270mm
- » Combined User Interface and Power Controller
- » For all NS heaters 2,3 – 9,0kW, for 9,0 – 18,0kW add Saunova 2.0 Contactor Unit
- » Smart heater control feature for automatic heat control
- » Compatible with Door Sensor
- » Opcional Fan and Combi features

Saunova 2.0 Contactor Unit (SAU-PS-V2)

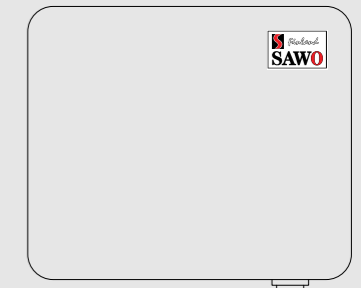
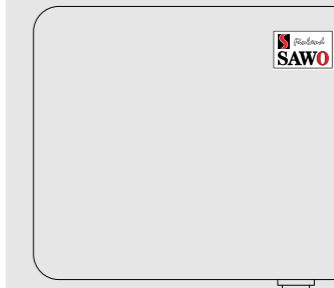

! Required for higher than a 9,0kW power supply.

## Saunova Simple (SAU-UI-S)

- » Dimensions: (L) 37 x (W) 104 x (H) 147mm
- » For those looking for simplicity on sauna heater control. Enables the to focus on the basics, turning the heater on / off.

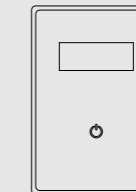



**Innova Classic 2.0 (INC-S-V2)**

- » Dimensions: (L) 37 x (W) 104 x (H) 147mm
- » Direct control for all Ni heaters, for NS heaters 2,3 – 15,0kW add the Innova 2.0 Power Controller, for 15,0 – 30,0kW add Innova 2.0 Contactor Unit
- » Smart heater control feature for automatic heat control
- » Compatible with Door Sensor
- » Opcionasal Fan and Combi features

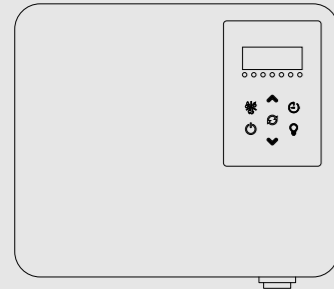

**Innova Classic 2.0 Mandos integrados (INC-B-V2)**

- » Dimensions: (L) 80 x (W) 320 x (H) 270mm
- » Combined User Interface and Power Controller
- » For all NS Heaters 2,3 – 15,0kW, connect with Innova 2.0 Contactor Unit for 15,0 – 30,0kW heaters
- » Smart heater control feature for automatic heat control
- » Opcionasal Fan and Combi features



**Innova Acero inoxidable táctil (INT-S-SST)**

- » Dimensions: (L) 37 x (W) 147 x (H) 104mm
- » Direct control for all Ni heaters, for NS heaters 2,3 – 15,0kW add the Innova 2.0 Power Controller, for 15,0 – 30,0kW add Innova 2.0 Contactor Unit
- » Smart heater control feature for automatic heat control
- » Compatible with Door Sensor
- » Opcionasal easy mode
- » Power blackout memory
- » Opcionasal Fan, Dimmer and Combi features

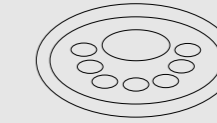

**Innova Classic (INC-S)**

- » Dimensions: (L) 31 x (W) 180 x (H) 105mm
- » Direct control for all Ni heaters, for NS heaters 2,3 – 15,0kW add the Innova 2.0 Power Controller, for 15,0 – 30,0kW add the Innova 2.0 Contactor Unit
- » Smart heater control feature for automatic heat control
- » Compatible with Door Sensor
- » Pre-run timer
- » Opcionasal Fan, Dimmer and Combi features

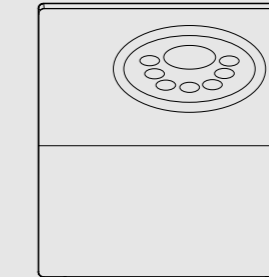

**Innova Classic Mandos integrados (INC-B)**

- » Dimensions: (L) 75 x (W) 245 x (H) 265mm
- » Combined User Interface and Power Controller
- » For all NS Heaters 2,3 – 15,0kW, for 15,0 – 30,0kW add the Innova 2.0 Contactor Unit
- » Smart heater control feature for automatic heat control
- » Opcionasal Fan, Dimmer and Combi features

Innova 2.0 Power Controller (INP-C-V2)

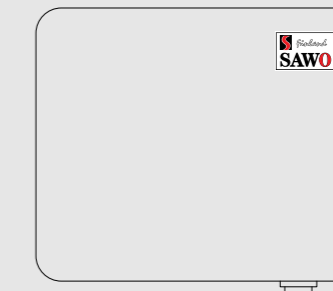

Innova 2.0 Contactor Unit (INP-S-V2)

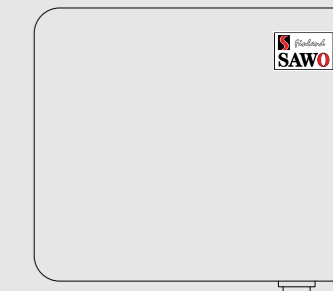

! Required for higher than a 9,0kW power supply.



INCLUSIONS



RJ12 Cable

código:	length:
INN-R50	50m
INN-R25	25m
INN-R10	10m
INN-R5	5m



Temperature Sensor with Fuse  
INN-FTEMP

OpcionesAL ITEMS

INTERFACE HOLDERS

» For Saunova 2.0, Innova Classic 2.0, Innova Acero inoxidable táctil, Innova Classic, Steam 2.0, Steam Acero inoxidable táctil, and Steam STE controls



INN-IH23-Z | INN-IH23-A | INN-IH23-D



INN-IH10-Z | INN-IH10-A | INN-IH10-D



INN-IH20-Z | INN-IH20-A | INN-IH20-D

TEMPERATURE SENSORS



Additional Second Temperature Sensor  
INN-BTEMP



Additional Humidity and Temperature Sensor  
INN-HUM

# ACCESORIOS Para Saunas

Nuestra destacada colección de accesorios para sauna: desde cucharones hasta cubos y lotes completos. Complementa a la perfección cualquier diseño de sauna.



## Rustic

El set Rustic combina estilo, sostenibilidad y diseño funcional. Algunas piezas pueden incorporar madera ensamblada con juntas tipo finger-joint, una solución ecológica de cero desperdicio en la que cada parte de la madera tiene un propósito.

código: SET-RUSTIC

SET INCLUDES: Madera Pail 4L Rustic, Madera Ladle Rustic (42cm), Madera Thermometer Rustic, Madera Sandtimer Rustic, Aroma Cup, Aroma Oil Eucalyptus Scent (250ml), Sauna Signage Pináceas, and Sauna Guidelines Pináceas

códigos: 339-Z, 430-Z, 220-TZ, 553-Z, R-100, ARO-EUCA250, 950-P, and 955-P



## Essential

El juego Essential lleva el confort y el estilo a un nivel superior, ofreciendo una colección más amplia de accesorios esenciales para disfrutar plenamente de la sauna.

código: SET-ESS

SET INCLUDES: Madera Pail 4L Western Red Cedro, Madera Ladle Western Red Cedro (42cm), Madera Thermo hygrometer Western Red Cedro, Madera Sandtimer Western Red Cedro, Aroma Cup, Aroma Oil Eucalyptus Scent (250ml), Sauna Signage Pináceas, and Sauna Guidelines Pináceas

códigos: 340-D, 430-D, 221-TFHD, 553-D, R-100, ARO-EUCA250, 950-P, and 955-P



## Signature

El distinguido set Signature está pensado para quienes buscan una experiencia de sauna elegante, sofisticada y a la altura de las mayores exigencias.

código: SET-SIG-BL

SET INCLUDES: Madera Pail Kanto 4L Black, Madera Ladle Puro (51cm) Black, Thermo-Hygrometer Square Black, Madera Sandtimer Black, Madera Pillow Wave Black, Aroma Cup, Aroma Oil Eucalyptus Scent (250ml), Sauna Signage Black, and Sauna Guidelines Pináceas

códigos: 347-BL, 459-BL, 225-THBL, 554-BL, 515-BL, R-100, ARO-EUCA250, 950-BL, and 955-P

código: SET-SIG-D

SET INCLUDES: Madera Pail Kanto 4L Cedro, Madera Ladle Puro (51cm) Cedro, Thermo-Hygrometer Square Cedro, Madera Sandtimer Cedro, Madera Pillow Wave Cedro, Aroma Cup, Aroma Oil Eucalyptus Scent (250ml), Sauna Signage Pináceas, and Sauna Guidelines Pináceas

códigos: 347-D, 459-D, 225-THD, 554-D, 515-D, R-100, ARO-EUCA250, 950-P, and 955-P



## Dragon

Con un estilo e innovación incomparables, el Dragon Set aporta una estética única y atrevida, llena de carácter.

código: SET-DRAGON

SET INCLUDES: Dragon Pail 4L Cedro, Madera Ladle Dragon Cedro, Thermo-Hygrometer Square Cedro, Madera Sandtimer Cedro with stone, Madera Pillow Wave Cedro, Aroma Cup, Aroma Oil Eucalyptus Scent (250ml), Sauna Signage Pináceas, and Sauna Guidelines Pináceas

códigos: 342-D, 449-D, 225-THD, 549-RD, 515-D, R-100, ARO-EUCA250, 950-P, and 955-P

código: SET-DRAGON-BL

SET INCLUDES: Dragon Pail 4L Black, Madera Ladle Dragon Black, Thermo-Hygrometer Square Black, Madera Sandtimer Black with stone, Madera Pillow Wave Black, Aroma Cup, Aroma Oil Eucalyptus Scent (250ml), Sauna Signage Black, and Sauna Guidelines Pináceas

códigos: 342-BL, 449-BL, 225-THBL, 549-RBL, 515-BL, R-100, ARO-EUCA250, 950-BL, and 955-P



## Cubo de Ducha

El cubo de ducha incluye una cuerda en la palanca, manguera y válvula de flotador. Su soporte en forma de arco ofrece más posibilidades de instalación, permitiendo fijarlo tanto en el techo como en la pared.

El cubo de ducha es apto para uso interior o exterior. La manguera debe conectarse a una entrada de agua para que, cuando el cubo se vacíe, se rellene automáticamente, creando una experiencia de ducha inagotable.



Pail Shower

código: 393-P | D | BL  
 capacity: 18L  
 Opciones: Pináceas | Cedro | Black

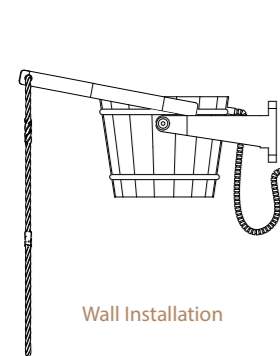

Wall Installation



Ceiling Installation



## Cubos



Kanto  
 código: 347-P | 347-WH | 347-BL  
 capacity: 4L  
 Opciones: Pináceas | White | Black



Lovi  
 código: 346-P | 346-WH | 346-BL  
 capacity: 4L  
 Opciones: Pináceas | White | Black



Usva  
 código: 374-MA | 374-MD  
 capacity: 5L  
 Opciones: Aspen | Cedro



Acero inoxidable Pail with Curved Handle  
 código: 373-MA | 373-MD  
 capacity: 5L  
 Opciones: Aspen | Cedro



Acero inoxidable Pail with Madera Handle  
 código: 375-MP | 375-MA | 375-MD  
 capacity: 5L  
 Opciones: Pináceas | Aspen | Cedro



Madera Pail Rattan with Acero inoxidable Insert  
 código: 371-MP | 371-MA | 371-MD  
 capacity: 5L  
 Opciones: Pináceas | Aspen | Cedro



Dragon Pail 4L  
 código: 342-D | 342-BL  
 capacity: 4L  
 Opciones: Cedro | Black



Dragon Pail 9L  
 código: 300-D | 300-BL  
 capacity: 9L  
 Opciones: Cedro | Black



Madera Pail Traditional  
 código: 300-TP | 300-TA | 300-TD  
 capacity: 9L  
 Opciones: Pináceas | Aspen | Cedro



Madera Pail Rattan  
 código: 300-HP | 300-HA | 300-HD  
 capacity: 9L  
 Opciones: Pináceas | Aspen | Cedro



Madera Pail Rustic  
 código: 339-Z  
 capacity: 4L  
 Opciones: Pináceas



Madera Pail Classic  
 código: 340-P | 340-A | 340-D  
 capacity: 4L  
 Opciones: Pináceas | Aspen | Cedro



Madera Pail Rattan  
 código: 341-P | 341-A | 341-D  
 capacity: 4L  
 Opciones: Pináceas | Aspen | Cedro



Steamwater Pail 4L  
 código: 342-D-DRF | 342-BL-DRF  
 capacity: 4L  
 Opciones: Cedro | Black



Steamwater Pail 9L  
 código: 300-D-DRF | 300-BL-DRF  
 capacity: 9L  
 Opciones: Cedro | Black



Madera Pail 18L  
 código: 381-P | 381-A | 381-D  
 capacity: 18L  
 Opciones: Pináceas | Aspen | Cedro



Madera Cover for 381  
 código: 381-P-COV | 381-A-COV | 381-D-COV  
 Cover for 381 pail  
 use: Pináceas | Aspen | Cedro  
 Opciones:



Madera Pail 28L  
 código: 391-P | 391-A | 391-D  
 capacity: 28L  
 Opciones: Pináceas | Aspen | Cedro



Madera Cover for 391  
 código: 391-P-COV | 391-A-COV | 391-D-COV  
 Cover for 391 pail  
 use: Pináceas | Aspen | Cedro  
 Op-



Madera Pail 40L  
 código: 392-P | 392-A | 392-D  
 capacity: 40L  
 Opciones: Pináceas | Aspen | Cedro



Madera Cover for 392  
 código: 392-P-COV | 392-A-COV | 392-D-COV  
 Cover for 392 pail  
 use: Pináceas | Aspen | Cedro  
 Op-

# Ladles

**Madera Ladle Standard 36cm**  
 código: 430-P | 430-A | 430-D  
 tamaño: 360mm  
 Op- Pináceas | Aspen | Cedro

**Madera Ladle Standard 42cm**  
 código: 440-P | 440-A | 440-D  
 tamaño: 420mm  
 Op- Pináceas | Aspen | Cedro

**Madera Ladle Standard 52cm**  
 código: 443-P | 443-A | 443-D  
 tamaño: 520mm  
 Op- Pináceas | Aspen | Cedro

**Madera Ladle Standard 68cm**  
 código: 444-P | 444-D | 444-D  
 tamaño: 680mm  
 Op- Pináceas | Aspen | Cedro



**Madera Ladle Puro 51cm**  
 código: 459-P | 459-D | 459-BL  
 tamaño: 510mm  
 Op- Pináceas | Cedro | Black

**Madera Ladle Puro 67cm**  
 código: 460-P | 460-D | 460-BL  
 tamaño: 670mm  
 Op- Pináceas | Cedro | Black

**Madera Ladle Puro 81cm**  
 código: 461-P | 461-D | 461-BL  
 tamaño: 810mm  
 Op- Pináceas | Cedro | Black

**Kanto Ladle**  
 código: 451-MP | 451-MWH | 451-MBL  
 tamaño: 520mm  
 Op- Pináceas | White | Black

**Dragon Ladle**  
 código: 449-D | 449-BL  
 tamaño: 498mm  
 Op- Cedro | Black

**Steamshot Ladle**  
 código: 449-D-DRF | 449-BL-DRF  
 tamaño: 498mm  
 Op- Cedro | Black

**Acero inoxidable Ladle 40cm**  
 código: 441-MP | 441-MA | 441-MD  
 tamaño: 400mm  
 Op- Pináceas | Aspen | Cedro

**Acero inoxidable Ladle Siro 46.5cm**  
 código: 445-MP | 445-MA | 445-MD  
 tamaño: 465mm  
 Op- Pináceas | Aspen | Cedro

**Acero inoxidable Ladle Usva 40cm**  
 código: 442-MP | 442-MA | 442-MD  
 tamaño: 400mm  
 Op- Pináceas | Aspen | Cedro

**Acero inoxidable Ladle with Curved Handle**  
 código: 453-MD | 453-MA  
 tamaño: 460mm  
 Op- Cedro | Aspen

**Acero inoxidable Ladle Siro 70.5cm**  
 código: 446-MP | 446-MA | 446-MD  
 tamaño: 705mm  
 Op- Pináceas | Aspen | Cedro

# Termómetros y Medidores Combinados



**Loisto Square Thermometer**  
 código: 108-TD  
 tamaño: 110 x 85mm  
 Op- Cedro

**Loisto Rounded Thermometer**  
 código: 109-TD  
 tamaño: 110 x 85mm  
 Op- Cedro

**Kanto Thermometer**  
 código: 104-TD | 104-TWH | 104-TBL  
 tamaño: 125 x 125mm  
 Opciones: Cedro | White | Black

**Black Metal Thermometer**  
 código: 295-TMBL  
 tamaño: 110 x 110mm  
 Op- Black Metal

**Black Metal Thermo-Hygrometer**  
 código: 295-THMBL  
 tamaño: 220 x 110mm  
 Op- Black Metal

**Accent Stone Thermometer**  
 código: 280-TRP | 280-TRA | 280-TRD  
 tamaño: 125 x 160mm  
 Op- Pináceas | Aspen | Cedro

**Cut Corner Square Thermometer**  
 código: 220-TP | 220-TA | 220-TD  
 tamaño: 140 x 140mm  
 Op- Pináceas | Aspen | Cedro

**Square Thermometer**  
 código: 223-TP | 223-TA | 223-TD  
 tamaño: 140 x 140mm  
 Op- Pináceas | Aspen | Cedro

**Octagon Thermometer**  
 código: 240-TP | 240-TA | 240-TD  
 tamaño: 165 x 180mm  
 Op- Pináceas | Aspen | Cedro

**Water Drop Thermometer**  
 código: 250-TP | 250-TA | 250-TD  
 tamaño: 150 x 180mm  
 Op- Pináceas | Aspen | Cedro

**Accent Stone Thermo-Hygrometer**  
 código: 281-THRP | THRA | THRD  
 tamaño: 160 x 185mm  
 Op- Pináceas | Aspen | Cedro

**Accent Stone Rectangle Thermo-Hygrometer**  
 código: 282-THRP | THRA | THRD  
 tamaño: 255 x 155mm  
 Op- Pináceas | Aspen | Cedro

**Accent Stone Vertical Thermo-Hygrometer**  
 código: 283-THVRP | THVRA | THVRD  
 tamaño: 155 x 255mm  
 Op- Pináceas | Aspen | Cedro

**Water Drop Thermo-Hygrometer**  
 código: 251-THP | THA | THD  
 tamaño: 185 x 225mm  
 Op- Pináceas | Aspen | Cedro

**Octagon Thermo-Hygrometer**  
 código: 241-THP | THA | THD  
 tamaño: 175 x 225mm  
 Op- Pináceas | Aspen | Cedro

**Square Thermo-Hygrometer**  
 código: 225-THP | THA | THD | THBL  
 tamaño: 180 x 180mm  
 Op- Pináceas | Aspen | Cedro | Black  
 ciones:

**Curved Square Thermo-Hygrometer**  
 código: 285-THP | THA | THD  
 tamaño: 170 x 175mm  
 Op- Pináceas | Aspen | Cedro  
 ciones:

**Basic Curved Rectangle Thermo-Hygrometer**  
 código: 271-THBP | THBA | THBD  
 tamaño: 225 x 140mm  
 Op- Pináceas | Aspen | Cedro

**Rectangle Thermo-Hygrometer**  
 código: 224-THP | THA | THD  
 tamaño: 255 x 140mm  
 Op- Pináceas | Aspen | Cedro

**Curved Rectangle Thermo-Hygrometer**  
 código: 271-THP | THA | THD  
 tamaño: 225 x 140mm  
 Op- Pináceas | Aspen | Cedro

**Cut Corner Rectangle Thermo-Hygrometer**  
 código: 221-THP | 221-THA | 221-THD  
 tamaño: 225 x 140mm  
 Op- Pináceas | Aspen | Cedro

**Cut Corner Vertical Rectangle Thermo-Hygrometer**  
 código: 221-THVP | THVA | THVD  
 tamaño: 136 x 251mm  
 Op- Pináceas | Aspen | Cedro

**Rounded Rectangle Thermo-Hygrometer**  
 código: 222-THP | THA | THD  
 tamaño: 225 x 140mm  
 Op- Pináceas | Aspen | Cedro

## Relojes



Loisto Madera Clock Square  
código: 534-D  
tamaño: 180 x 180mm  
Op- Cedro



Loisto Madera Clock Round  
código: 535-D  
tamaño: Ø180mm  
Op- Cedro



Madera Pail Clock  
código: 530-P | 530-A | 530-D  
tamaño: Ø260 x 90mm  
Op- Pináceas | Aspen | Cedro



Madera Pail Clock Small  
código: 531-P | 531-A | 531-D  
tamaño: Ø230 x 40mm  
Op- Pináceas | Aspen | Cedro

## Relojes de arena



Sand Timer 15min Stone  
código: 549-RA | 549-RD | 549-RBL  
tamaño: 65 x 340mm  
Op- Aspen | Cedro | Black



Sand Timer 15min  
código: 553-P | 553-A | 553-D | 553-BL  
tamaño: 65 x 340mm  
Op- Aspen | Pináceas | Cedro  
Opciones: | Black



Sand Timer Kanto 15min  
código: 554-A | 554-D | 554-BL  
tamaño: 65 x 340mm  
Op- Aspen | Cedro | Black



Sand Timer Tag 15min  
código: 550-P | 550-A | 550-D  
tamaño: 65 x 340mm  
Op- Pináceas | Aspen | Cedro

## Reposacabezas y respaldos



Wave Madera Backrest  
código: 506-2-A | 506-2-D | 506-2-BL  
tamaño: 390 x 845mm  
Op- Aspen | Cedro | Black



Wave Madera Headrest  
código: 515-A | 515-D | 515-BL  
tamaño: 190 x 480mm  
Op- Aspen | Cedro | Black



Halu Madera Headrest  
código: 512-A | 512-D  
tamaño: 180 x 230mm  
Op- Aspen | Cedro



Halu Anti-theft Headrest  
código: 513-A | 513-D  
tamaño: 190 x 480mm  
Op- Aspen | Cedro



Madera Backrest  
código: 516-P | 516-A | 516-D  
tamaño: 396 x 515mm  
Op- Pináceas | Aspen | Cedro



Madera Backrest  
código: 514-A | 514-D  
tamaño: 346 x 888mm  
Op- Aspen | Cedro



## Bancos



Sauna Bench  
código: 520-D  
tamaño: 430 x 534 x 412mm  
Op- Cedro



Sauna Bench  
código: 521-D  
tamaño: 430 x 870 x 412mm  
Op- Cedro



Sauna Bench  
código: 522-D  
tamaño: 500 x 870 x 510mm  
Op- Cedro



Sauna Bench  
código: 523-D  
tamaño: 500 x 1200 x 510mm  
Op- Cedro



Sauna Bench 2-Layers  
código: 524-D  
tamaño: 760 x 534 x 562mm  
Op- Cedro



Siro Sauna Bench 42cm  
código: 528-D  
tamaño: 290 x 420 x 420mm  
Op- Cedro



Siro Sauna Bench 85cm  
código: 529-D  
tamaño: 290 x 850 x 420mm  
Op- Cedro



Siro Sauna Bench 120cm  
código: 529-L-D  
tamaño: 290 x 1200 x 420mm  
Op- Cedro



Siro Wide Sauna Bench 42cm  
código: 628-D  
tamaño: 440 x 420 x 420mm  
Op- Cedro



Siro Wide Sauna Bench 85cm  
código: 629-D  
tamaño: 440 x 850 x 420mm  
Op- Cedro



Siro Wide Sauna Bench 120cm  
código: 629-L-D  
tamaño: 440 x 1200 x 420mm  
Op- Cedro

## Percheros



Madera Cloth Hanger - 3 Holders  
código: 582-P | 582-A | 582-D  
tamaño: 42 x 240mm  
Op- Pináceas | Aspen | Cedro



Madera Cloth Hanger - 4 Holders  
código: 586-P | 586-A | 586-D  
tamaño: 42 x 340mm  
Op- Pináceas | Aspen | Cedro



Madera Cloth Hanger - 5 Holders  
código: 583-P | 583-A | 583-D  
tamaño: 42 x 440mm  
Op- Pináceas | Aspen | Cedro



Madera Floor Mat Block  
código: 595-P-BC | 595-A-BC | 595-D-BC  
tamaño: 285 x 285mm  
thickness: 22mm  
Opciones: Pináceas | Aspen | Cedro



Madera Floor Mat Corner Frame  
código: 595-P-CNR | 595-A-CNR | 595-D-CNR  
tamaño: 390 x 115mm  
thickness: 22mm  
Opciones: Pináceas | Aspen | Cedro



Madera Floor Mat Sides  
código: 595-P-SID | 595-A-SID | 595-D-SID  
tamaño: 285 x 115mm  
thickness: 22mm  
Opciones: Pináceas | Aspen | Cedro

## Luces para sauna y pantallas de luz



Madera Curve Light 237  
código: 923-D | 923-D-SET  
tamaño: 240 x 85 x 60mm  
Op- Cedro

NOTE: Set includes 2 lights



Madera Curve Light 365  
código: 924-D | 924-D-SET  
tamaño: 364 x 85 x 60mm  
Op- Cedro

NOTE: Set includes 2 lights



Madera Curve Light 610  
código: 925-D | 925-D-SET  
tamaño: 614 x 85 x 60mm  
Op- Cedro

NOTE: Set includes 2 lights



Madera Light Cover Square  
código: 910-SP | 910-SA | 910-SD  
tamaño: 250 x 75mm  
Op- Pináceas | Aspen | Cedro



Madera Light Cover Square  
código: 911-LP | 911-LA | 911-LD  
tamaño: 250 x 135mm  
Op- Pináceas | Aspen | Cedro



Madera Light Cover Corner/Wall  
código: 914-VP | 914-VA | 914-VD  
tamaño: 150 x 110mm  
Op- Pináceas | Aspen | Cedro



Madera Light Cover Wave  
código: 917-P | 917-A | 917-D  
tamaño: 207 x 280mm  
Op- Pináceas | Aspen | Cedro

## Manillas de puerta



Madera Arc Door Handle  
 código: 558-A | 558-D  
 tamaño: 40 x 900mm  
 Op- Aspen | Cedro



Madera Straight Door Handle with metal Accent  
 código: 560-A | 560-D | 560-BL  
 tamaño: 155 x 900mm  
 Op- Aspen | Cedro | Black



Madera Door Handle Small Round  
 código: 565-P | 565-A | 565-D  
 tamaño: Ø65 x W70mm  
 Op- Pináceas | Aspen | Cedro



Madera Door Handle Big Round  
 código: 566-P | 566-A | 566-D  
 tamaño: Ø90 x W50mm  
 Op- Pináceas | Aspen | Cedro



Madera Door Handle with Magnetic Lock  
 código: 568-P | 568-A | 568-D  
 tamaño: 260 x 45mm  
 Op- Pináceas | Aspen | Cedro



Door Hinge Round  
 código: 571 | 571-BL  
 tamaño: 90 x 70mm  
 Op- Aluminum | Black



Door Lock Magnet Round, Heavy-Duty  
 código: 574  
 tamaño: 17 x 28.5mm  
 Opciones: Aluminum

## Ventilación



Ventilation Cover Circle  
 código: 640-BR  
 tamaño: Ø160mm  
 Opciones: Metallic Brown



Ventilation Louver Circle  
 código: 631-P | 631-A | 631-D  
 tamaño: Ø145mm  
 ductinghole: 100mm  
 Opciones: Pináceas | Aspen | Cedro



Ventilation Louver Circle  
 código: 634-P | 634-A | 634-D  
 tamaño: Ø170mm  
 ductinghole: 125mm  
 Opciones: Pináceas | Aspen | Cedro



Ventilation Louver Square  
 código: 620-P | 620-A | 620-D  
 tamaño: 215 x 170mm  
 Op- Pináceas | Aspen | Cedro  
 ciones:



Ventilation Louver Square  
 código: 638-P | 638-A | 638-D | 638-BL  
 tamaño: Ø145mm  
 ductinghole: 100mm  
 Opciones: Pináceas | Aspen | Cedro | Black



Ventilation Louver Circle  
 código: 639-P | 639-A | 639-D | 639-BL  
 tamaño: Ø170mm  
 ductinghole: 125mm  
 Opciones: Pináceas | Aspen | Cedro | Black

## Display Stand Wall



Display Stand Wall 1  
 código: DP-15  
 go: (W)1110 x (D)630 x (H)2000mm



Display Stand Wall 2  
 código: DP-16  
 go: (W)2300 x (D)630 x (H)2000mm



Display Stand Wall 3  
 código: DP-17  
 go: (W)3400 x (D)630 x (H)2000mm

## Add Ons



Sauna Signage  
 código: 950-BL | 950-P | 950-A | 950-D  
 tamaño: 150 x 80mm  
 Op- Pináceas | Aspen | Cedro | Black



Moisture Paper  
 código: SP02-900  
 go: 1,200mm x 77mm x 77mm



# Puertas



**Madera Stripe Puerta de sauna**  
 código: 770-4SD-R | 770-4SD-L  
 Medidas abierta: 610 x 1935mm  
 Marco: 700 x 2040mm  
 Opciones: Cedro



**Madera Stripe Puerta de sauna**  
 código: 771-4SD-R | 771-4SD-L  
 Medidas abierta: 915 x 2015mm  
 Marco: 1005 x 2120mm  
 Opciones: Cedro



**Madera Reversible Puerta de sauna**  
 código: 773-4SP | 773-4SA | 773-4SD  
 Medidas abierta: 915 x 2015mm  
 Marco: 1005 x 2120mm  
 Opciones: Pináceas | Aspen | Cedro



**Madera Reversible Puerta de sauna**  
 código: 734-4SP | 734-4SA | 734-4SD  
 Medidas abierta: 610 x 1935mm  
 Marco: 700 x 2040mm  
 Opciones: Pináceas | Aspen | Cedro



**Clear Glass Reversible Puerta de sauna**  
 código: 730-4SCP | 730-4SCA | 730-4SCD  
 Medidas abierta: 600 x 1800mm  
 Medidas marco: 690 x 1890mm  
 Opciones: Pináceas | Aspen | Cedro



**Clear Glass Reversible Puerta de sauna**  
 código: 731-4SCP | 731-4SCA | 731-4SCD  
 Medidas abierta: 700 x 1800mm  
 Medidas marco: 790 x 1890mm  
 Opciones: Pináceas | Aspen | Cedro



**Clear Glass Reversible Puerta de sauna with Vertical Madera Handle Arc**  
 código: 741-4SCD-1 | 741-4SCA-1  
 Medidas abierta: 600 x 1800mm  
 Medidas marco: 690 x 1890mm  
 Opciones: Aspen | Cedro



**Clear Glass Reversible Puerta de sauna with Vertical Madera Handle Metal**  
 código: 741-4SCA-3 | 741-4SCD-3  
 Medidas abierta: 600 x 1800mm  
 Medidas marco: 690 x 1890mm  
 Opciones: Aspen | Cedro



**Madera Door with Clear Glass Window**  
 código: 743-4SCP-R | L / 743-4SCA-R | L / 743-4SCD-R | L  
 Medidas abierta: 600 x 1800mm  
 Medidas marco: 690 x 1890mm  
 Opciones: Pináceas | Aspen | Cedro



**Madera Door with Bronze Glass Window**  
 código: 743-4SGP-R | L / 743-4SGA-R | L / 743-4SGD-R | L  
 Medidas abierta: 600 x 1800mm  
 Medidas marco: 690 x 1890mm  
 Opciones: Pináceas | Aspen | Cedro



**Madera Puerta de sauna with Window**  
 código: 736-4SGP-R | L / 736-4SGA-R | L / 736-4SGD-R | L  
 Medidas abierta: 915 x 2015mm  
 Medidas marco: 1005 x 2120mm  
 Opciones: Pináceas | Aspen | Cedro



**Bronze Glass Reversible Puerta de sauna with Arc Handle**  
 código: 741-4SGD-1 | 741-4SGA-1 | 741-4SGP-1  
 Medidas abierta: 600 x 1800mm  
 Medidas marco: 690 x 1890mm  
 Opciones: Pináceas | Aspen | Cedro



**Bronze Glass Reversible Puerta de sauna with Metallic Handle**  
 código: 741-4SGD-3 | 741-4SGA-3 | 741-4SGP-3  
 Medidas abierta: 600 x 1800mm  
 Medidas marco: 690 x 1890mm  
 Opciones: Pináceas | Aspen | Cedro



**Bronze Glass Reversible Puerta de sauna Standard**  
 código: 730-4SGD | 730-4SGA | 730-4SGP  
 Medidas abierta: 600 x 1800mm  
 Medidas marco: 690 x 1890mm  
 Opciones: Pináceas | Aspen | Cedro



**Bronze Glass Reversible Puerta de sauna Standard**  
 código: 731-4SGD | 731-4SGA | 731-4SGP  
 Medidas abierta: 700 x 1800mm  
 Medidas marco: 790 x 1890mm  
 Opciones: Pináceas | Aspen | Cedro



**Madera Wide Clear Window Puerta de sauna**  
 código: 739-3SCP-R | L / 739-3SCA-R | L / 739-3SCD-R | L  
 Medidas 124 x 1003 x 2075mm  
 marco: Pináceas | Aspen | Cedro



**Madera Wide Bronze Window Puerta de sauna**  
 código: 739-3SGP-R | L / 739-3SGA-R | L / 739-3SGD-R | L  
 Medidas marco: 124 x 1005 x 2075mm  
 Opciones: Pináceas | Aspen | Cedro

**Left-handed Bronze Glass Puerta de sauna Finland with Arc Handle**  
 código: 741-3SGD-L-1 | 741-3SGA-L-1 | 741-3SGP-L-1  
 Glass tamaño: 600 x 1800mm  
 Medidas 690 x 1890mm  
 marco: Pináceas | Aspen | Cedro

**Left-handed Bronze Glass Puerta de sauna Finland with Metallic Handle**  
 código: 741-3SGD-L-3 | 741-3SGA-L-3 | 741-3SGP-L-3  
 Medidas abierta: 600 x 1800mm  
 Medidas marco: 690 x 1890mm  
 Opciones: Pináceas | Aspen | Cedro

**Left-handed Bronze Glass Puerta de sauna Finland**  
 código: 730-3SGD-L | 730-3SGA-L | 730-3SGP-L  
 Medidas abierta: 600 x 1800mm  
 Medidas marco: 690 x 1890mm  
 Opciones: Pináceas | Aspen | Cedro

**Left-handed Bronze Glass Puerta de sauna Finland**  
 código: 731-3SGD-L | 731-3SGA-L | 731-3SGP-L  
 Medidas abierta: 700 x 1800mm  
 Medidas marco: 790 x 1890mm  
 Opciones: Pináceas | Aspen | Cedro

**Right-handed Bronze Glass Puerta de sauna Finland with Arc Handle**  
 código: 741-3SGD-R-1 | 741-3SGA-R-1 | 741-3SGP-R-1  
 Medidas abierta: 600 x 1800mm  
 Medidas marco: 690 x 1890mm  
 Opciones: Pináceas | Aspen | Cedro

**Right-handed Bronze Glass Puerta de sauna Finland with Metallic Handle**  
 código: 741-3SGD-R-3 | 741-3SGA-R-3 | 741-3SGP-R-3  
 Medidas abierta: 600 x 1800mm  
 Medidas marco: 690 x 1890mm  
 Opciones: Pináceas | Aspen | Cedro

**Right-handed Bronze Glass Puerta de sauna Finland**  
 código: 730-3SGD-R | 730-3SGA-R | 730-3SGP-R  
 Medidas abierta: 600 x 1800mm  
 Medidas marco: 690 x 1890mm  
 Opciones: Pináceas | Aspen | Cedro

**Right-handed Bronze Glass Puerta de sauna Finland**  
 código: 731-3SGD-R | 731-3SGA-R | 731-3SGP-R  
 Medidas abierta: 700 x 1800mm  
 Medidas marco: 790 x 1890mm  
 Opciones: Pináceas | Aspen | Cedro

# KIVISTONE®

Kivistone es una colección de hermosos accesorios tallados en piedra de jabón finlandesa.

Cada pieza está diseñada de manera única para la decoración del hogar, el uso cotidiano y como regalo personal o corporativo.

Descubre la amplia selección, creados en piedra de jabón.

- » Enfriadores y juegos de enfriadores
- » Cazoletas aromáticas y cuencos para esencias
- » Artículos varios

! sawo.com para más accesorios or more accessories



Luxury Aroma Cup (ø)50  
código: R-160  
tamaño: 50 x 50 x 50mm  
weight: 0,2kG

Aroma Cup (ø)50  
código: R-100  
tamaño: 50 x 50 x 60mm  
weight: 0,3kG

Aroma Spirit Cup  
código: R-501  
tamaño: 75 x 75 x 120mm  
weight: 0,7kG

Scent Warmer  
código: R-123  
tamaño: 75 x 75 x 80mm  
weight: 0,7kG



Wine Cooler Stone  
código: R-93-D  
tamaño: 230 x 155 x 84mm  
material: Piedra de jabón/Cedro



Spa Stones Set  
código: R-500-D  
tamaño: 90 x 128 x 178mm  
material: Piedra de jabón/  
Cedro



Cooler (1 hole)  
código: R-141  
tamaño: 100 x 100 x 75mm  
weight: 1,3kG



# Sauna de VAPOR

Nuestros generadores de vapor ofrecen una experiencia profundamente relajante, perfecta para desconectar y revitalizar cuerpo y mente.





## STN-S Generador de Vapor

Diseñado para ofrecer potencia y alto rendimiento, el generador de vapor STN-S permite soluciones de instalación más flexibles.

Dispone de un compartimento electrónico separado, lo que significa que el generador puede instalarse en un lugar distinto al de la electrónica. Sus resistencias en formato cassette facilitan la limpieza y el mantenimiento del depósito, mientras que los controles de aromas, ventilador y regulador de luz permiten personalizar cada sesión de vapor.

El vapor extra está siempre disponible gracias al botón de demanda, que puede instalarse dentro o fuera de la sala de vapor.

Los códigos de error aparecen directamente en el panel de control para una resolución rápida.

Hasta cinco unidades pueden conectarse entre sí para alcanzar una potencia máxima de 75,0 kW, todas gestionadas desde un único control SAWO.

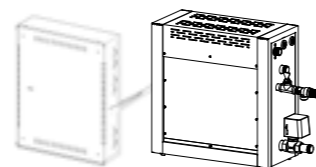

### 2 Resistencias eléctricas

STEAM GENERATOR MODEL	kW	STEAM ROOM		SIZE OF STEAM GENERATOR			WEIGHT (kg)	CONTROL
		MIN (m³)	MAX	LENGTH (mm)	WIDTH (mm)	HEIGHT (mm)		
STN-S-30-1/2	3,0		3	185	485	560	17	Stainless Touch   STN-S 2.0
STN-S-35-1/2	3,5		3,5	185	485	560	17	Stainless Touch   STN-S 2.0
STN-S-40-1/2	4,0		4	185	485	560	17	Stainless Touch   STN-S 2.0
STN-S-45-1/2	4,5	2	5	185	485	560	17	Stainless Touch   STN-S 2.0
STN-S-50-1/2	5,0	2	6	185	485	560	17	Stainless Touch   STN-S 2.0

### 3 Resistencias eléctricas

STEAM GENERATOR MODEL	kW	STEAM ROOM		SIZE OF STEAM GENERATOR			WEIGHT (kg)	CONTROL
		MIN (m³)	MAX	LENGTH (mm)	WIDTH (mm)	HEIGHT (mm)		
STN-S-45-3	4,5	2	5	220	485	560	19	Stainless Touch   STN-S 2.0
STN-S-60-3	6,0	3	10	220	485	560	19	Stainless Touch   STN-S 2.0
STN-S-60-C1/3	6,0	3	10	220	485	560	19	Stainless Touch   STN-S 2.0
STN-S-75-3	7,5	4	15	220	485	560	19	Stainless Touch   STN-S 2.0
STN-S-75-C1/3	7,5	4	15	220	485	560	19	Stainless Touch   STN-S 2.0

### 6 Resistencias eléctricas

STEAM GENERATOR MODEL	kW	STEAM ROOM		SIZE OF STEAM GENERATOR			WEIGHT (kg)	CONTROL
		MIN (m³)	MAX	LENGTH (mm)	WIDTH (mm)	HEIGHT (mm)		
STN-S-90-3	9,0	8	20	310	485	560	23	Stainless Touch   STN-W 2.0
STN-S-90-C1/3	9,0	8	20	310	485	560	23	Stainless Touch   STN-W 2.0
STN-S-120-3	12,0	15	28	310	485	560	23	Stainless Touch   STN-W 2.0
STN-S-150-3	15,0	22	40	310	485	560	23	Stainless Touch   STN-W 2.0

#### 2 Resistencias eléctricas

- » Rango de potencia: 3,0 – 5,0kW
- » Producción de vapor: 6,7kg/hr
- » Tuberías y cables eléctricos pueden instalarse en cualquiera de los dos lados
- » Tubo / válvula de sobrepresión
- » Válvula automática descarga de agua
- » Salida de vapor incluida
- » Conjunto de resistencias en formato cassette para facilitar el mantenimiento
- » 3/4" tubo de vapor
- » Paneles de control disponibles: Acero inoxidable táctil y Steam 2.0

#### 3 Resistencias eléctricas

- » Rango de potencia: 4,5 – 7,5kW
- » Producción de vapor: 7,5kg/hr
- » Tuberías y cables eléctricos pueden instalarse en cualquiera de los dos lados
- » Tubo / válvula de sobrepresión
- » Válvula automática descarga de agua
- » Salida de vapor incluida
- » Conjunto de resistencias en formato cassette para facilitar el mantenimiento
- » 3/4" tubo de vapor
- » Paneles de control disponibles: Acero inoxidable táctil y Steam 2.0

#### 6 Resistencias eléctricas

- » Rango de potencia: 9,0 – 15,0kW
- » Producción de vapor: 20kg/hr
- » Tuberías y cables eléctricos pueden instalarse en cualquiera de los dos lados
- » Tubo / válvula de sobrepresión
- » Válvula automática descarga de agua
- » 2 Salidas de vapor incluidas
- » Conjunto de resistencias en formato cassette para facilitar el mantenimiento
- » 3/4" tubo de vapor
- » Paneles de control disponibles: Acero inoxidable táctil y Steam 2.0



## STN-W Generador de Vapor

Diseñado para un uso intensivo, el STN-W es un generador de vapor de alto rendimiento pensado para aplicaciones comerciales. Incorpora un cassette para las resistencias, lo que permite una limpieza o sustitución rápida y sencilla.

Los controles de aromas, ventilación y regulador de luz permiten personalizar completamente la experiencia de vapor, mientras que el botón de demanda (opcional) ofrece una ráfaga extra de vapor cuando se necesite.

El mantenimiento y la instalación son muy sencillos. la salida de vapor puede instalarse a la izquierda o a la derecha, y el autodrenaje puede colocarse en el lateral o en la parte inferior.

Es posible conectar hasta cinco unidades para alcanzar una potencia máxima de 75,0 kW, todas controladas desde una única interfaz SAWO.

! Para más información técnica, consulte la página 94.

#### 2 Resistencias eléctricas

- » Rango de potencia: 3,0 – 5,0kW
- » Producción de vapor: 6,7kg/hr
- » Tubo / válvula de sobrepresión
- » Válvula automática descarga de agua
- » Salida de vapor incluida
- » Conjunto de resistencias en formato cassette para facilitar el mantenimiento
- » 3/4" tubo de vapor
- » Paneles de control disponibles: Acero inoxidable táctil y Steam 2.0

#### 3 Resistencias eléctricas

- » Rango de potencia: 4,5 – 7,5kW
- » Producción de vapor: 7,5kg/hr
- » Tubo / válvula de sobrepresión
- » Válvula automática descarga de agua
- » Salida de vapor incluida
- » Conjunto de resistencias en formato cassette para facilitar el mantenimiento
- » 3/4" tubo de vapor
- » Paneles de control disponibles: Acero inoxidable táctil y Steam 2.0

#### 6 Resistencias eléctricas

- » Rango de potencia: 9,0 – 15,0kW
- » Producción de vapor: 20kg/hr
- » Tubo / válvula de sobrepresión
- » Válvula automática descarga de agua
- » 2 Salidas de vapor incluidas
- » Conjunto de resistencias en formato cassette para facilitar el mantenimiento
- » 3/4" tubo de vapor
- » Paneles de control disponibles: Acero inoxidable táctil y Steam 2.0

# STN Generador de Vapor

Diseñado para las exigencias del uso comercial, el generador de vapor STN combina durabilidad y alto rendimiento.

Su sólida construcción en acero inoxidable minimiza la corrosión, mientras que una variedad de funciones opcionales —como controles de aroma, ventilador y regulación de luz (dimmer)— permiten personalizar completamente la experiencia de vapor.

Un botón de demanda opcional libera un extra de vapor durante 30 segundos cuando se necesita.

El sistema puede instalarse con salida hacia la izquierda o la derecha y conectarse en serie con hasta cinco unidades, alcanzando una potencia máxima de 75,0 kW, todas gestionadas desde una única interfaz SAWO.

! Para más información técnica, consulte la página 94.



## Datos técnicos

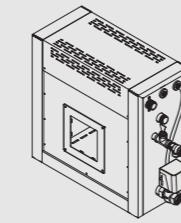

STN-W Generador de Vapor

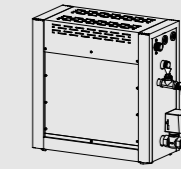

STN Generador de Vapor

### 2 Resistencias eléctricas

STEAM GENERATOR MODEL	kW	STEAM ROOM		SIZE OF STEAM GENERATOR			WEIGHT (KG)	CONTROL
		MIN (m³)	MAX	LENGTH (mm)	WIDTH (mm)	HEIGHT (mm)		
STN-W-30-1/2	3,0		3	245	485	560	17	Stainless Touch   STN-W 2.0
STN-W-35-1/2	3,5		3,5	245	485	560	17	Stainless Touch   STN-W 2.0
STN-W-40-1/2	4,0		4	245	485	560	17	Stainless Touch   STN-W 2.0
STN-W-45-1/2	4,5	2	5	245	485	560	17	Stainless Touch   STN-W 2.0
STN-W-50-1/2	5,0	2	6	245	485	560	17	Stainless Touch   STN-W 2.0

### 3 Resistencias eléctricas

STEAM GENERATOR MODEL	kW	STEAM ROOM		SIZE OF STEAM GENERATOR			WEIGHT (KG)	CONTROL
		MIN (m³)	MAX	LENGTH (mm)	WIDTH (mm)	HEIGHT (mm)		
STN-W-45-3	4,5	2	5	280	485	560	19	Stainless Touch   STN-W 2.0
STN-W-45-C1/3	4,5	2	5	280	485	560	19	Stainless Touch   STN-W 2.0
STN-W-60-3	6,0	3	10	280	485	560	19	Stainless Touch   STN-W 2.0
STN-W-60-C1/3	6,0	3	10	280	485	560	19	Stainless Touch   STN-W 2.0
STN-W-75-3	7,5	4	15	280	485	560	19	Stainless Touch   STN-W 2.0
STN-W-75-C1/3	7,5	4	15	280	485	560	19	Stainless Touch   STN-W 2.0

### 6 Resistencias eléctricas

STEAM GENERATOR MODEL	kW	STEAM ROOM		SIZE OF STEAM GENERATOR			WEIGHT (KG)	CONTROL
		MIN (m³)	MAX	LENGTH (mm)	WIDTH (mm)	HEIGHT (mm)		
STN-W-90-3	9,0	8	20	375	485	560	23	Stainless Touch   STN-W 2.0
STN-W-90-C1/3	9,0	8	20	375	485	560	23	Stainless Touch   STN-W 2.0
STN-W-120-3	12,0	15	28	375	485	560	23	Stainless Touch   STN-W 2.0
STN-W-150-3	15,0	22	40	375	485	560	23	Stainless Touch   STN-W 2.0

### 2 Resistencias eléctricas

STEAM GENERATOR MODEL	kW	STEAM ROOM		SIZE OF HEATER			WEIGHT (KG)	CONTROL
		MIN (m³)	MAX	LENGTH (mm)	WIDTH (mm)	HEIGHT (mm)		
STN-30-1/2	3,0		3	185	485	560	17	Touch   Classic   Classic 2.0
STN-35-1/2	3,5		3,5	185	485	560	17	Touch   Classic   Classic 2.0
STN-40-1/2	4,0		4	185	485	560	17	Touch   Classic   Classic 2.0
STN-45-1/2	4,5	2	5	185	485	560	17	Touch   Classic   Classic 2.0
STN-50-1/2	5,0	2	6	185	485	560	17	Touch   Classic   Classic 2.0

### 3 Resistencias eléctricas

STEAM GENERATOR MODEL	kW	STEAM ROOM		SIZE OF HEATER			WEIGHT (KG)	CONTROL
		MIN (m³)	MAX	LENGTH (mm)	WIDTH (mm)	HEIGHT (mm)		
STN-45-3	4,5	2	5	220	485	560	19	Touch   Classic   Classic 2.0
STN-45-C1/3	4,5	2	5	220	485	560	19	Touch   Classic   Classic 2.0
STN-60-3	6,0	3	10	220	485	560	19	Touch   Classic   Classic 2.0
STN-60-C1/3	6,0	3	10	220	485	560	19	Touch   Classic   Classic 2.0
STN-75-3	7,5	4	15	220	485	560	19	Touch   Classic   Classic 2.0
STN-75-C1/3	7,5	4	15	220	485	560	19	Touch   Classic   Classic 2.0

### 6 Resistencias eléctricas

STEAM GENERATOR MODEL	kW	STEAM ROOM		SIZE OF HEATER			WEIGHT (KG)	CONTROL
		MIN (m³)	MAX	LENGTH (mm)	WIDTH (mm)	HEIGHT (mm)		
STN-90-3	9,0	8	20	310	485	560	23	Touch   Classic   Classic 2.0
STN-90-C1/3	9,0	8	20	310	485	560	23	Touch   Classic   Classic 2.0
STN-120-3	12,0	15	28	310	485	560	23	Touch   Classic   Classic 2.0
STN-150-3	15,0	22	40	310	485	560	23	Touch   Classic   Classic 2.0



### 2 Resistencias eléctricas

- » Rango de potencia: 3,0 – 5,0kW
- » Producción de vapor: 6,7kg/hr
- » Puede instalarse en ambos lados
- » Tubo / válvula de sobrepresión
- » Válvula automática descarga de agua
- » Salida de vapor incluida
- » Cassette type heating element setup for easy maintenance
- » ¾" tubo de vapor
- » Paneles de control disponibles: Acero inoxidable táctil y Steam 2.0



### 3 Resistencias eléctricas

- » Rango de potencia: 4,5 – 7,5kW
- » Producción de vapor: 7,5kg/hr
- » Puede instalarse en ambos lados
- » Tubo / válvula de sobrepresión
- » Válvula automática descarga de agua
- » Salida de vapor incluida
- » Cassette type heating element setup for easy maintenance
- » ¾" tubo de vapor
- » Paneles de control disponibles: Acero inoxidable táctil y Steam 2.0



### 6 Resistencias eléctricas

- » Rango de potencia: 9,0 – 15,0kW
- » Producción de vapor: 20kg/hr
- » Puede instalarse en ambos lados
- » Tubo / válvula de sobrepresión
- » Válvula automática descarga de agua
- » 2 Salidas de vapor incluidas
- » Cassette type heating element setup for easy maintenance
- » ¾" tubo de vapor
- » Paneles de control disponibles: Acero inoxidable táctil y Steam 2.0

## INCLUIDO CON EL GENERADOR DE VAPOR



Caja electrónica (Incluido en modelo STN)



Autodrain (Incluido en: STN-S, STN-W y STN)



Funciones de aroma, ventilador y luz (Opciones para los modelos STN)



Sensor de temperatura con cable y soporte para sensor



Salida de vapor (1x incluido hasta 9kW, 2x para superiores)



7,5m RJ12 Cable  
7,5m RJ10 Cable

# STE Generador de Vapor

Fiable y fácil de usar, el generador de vapor STE está diseñado para entornos residenciales. Su funcionamiento también es sencillo: basta con encender el controlador y ajustar el nivel de temperatura. La estructura de acero inoxidable garantiza una larga durabilidad y una alta resistencia a la corrosión.

El STE puede instalarse con las conexiones orientadas hacia cualquiera de los dos lados, facilitando su integración en cualquier configuración.

Para aumentar la capacidad de potencia, es posible conectar hasta cinco unidades en serie, alcanzando una salida máxima de 75,0 kW, todas gestionadas desde un único controlador SAWO.

⚠ Para más información técnica, consulte la página 97.



### 2 Resistencias eléctricas

- » Rango de potencia: 3,0 - 5,0kW
- » Producción de vapor: 6,7kg/hr
- » Puede instalarse en ambos lados
- » Tubo / válvula de sobrepresión
- » Salida de vapor incluida
- » Paneles de control disponibles: STE 2.0



### 3 Resistencias eléctricas

- » Rango de potencia: 4,5 - 7,5kW
- » Producción de vapor: 7,5kg/hr
- » Puede instalarse en ambos lados
- » Tubo / válvula de sobrepresión
- » Salida de vapor incluida
- » Paneles de control disponibles: STE 2.0



### 6 Resistencias eléctricas

- » Rango de potencia: 9,0 - 15,0kW
- » Producción de vapor: 20kg/hr
- » Puede instalarse en ambos lados
- » Tubo / válvula de sobrepresión
- » 2 Salidas de vapor incluidas
- » Paneles de control disponibles: STE 2.0



## Datos técnicos

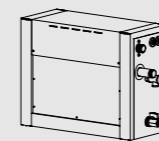

STE Generador de Vapor

### 2 Resistencias eléctricas

STEAM GENERATOR MODEL	kW	STEAM ROOM (m³)		SIZE OF HEATER (mm)			WEIGHT (kg)	CONTROL
		MIN	MAX	LENGTH	WIDTH	HEIGHT		
STE-30-1/2	3,0	3		205	465	555	16,5	STE Basic   Advance
STE-35-1/2	3,5	3,5		205	465	555	16,5	STE Basic   Advance
STE-40-1/2	4,0	4		205	465	555	16,5	STE Basic   Advance
STE-45-1/2	4,5	2	5	205	465	555	16,5	STE Basic   Advance
STE-50-1/2	5,0	2	6	205	465	555	16,5	STE Basic   Advance

### 3 Resistencias eléctricas

STEAM GENERATOR MODEL	kW	STEAM ROOM (m³)		SIZE OF HEATER (mm)			WEIGHT (kg)	CONTROL
		MIN	MAX	LENGTH	WIDTH	HEIGHT		
STE-45-C1/3	4,5	2	5	250	370	555	18	STE Basic   Advance
STE-60-C1/3	6,0	3	10	250	370	555	18	STE Basic   Advance
STE-75-C1/3	7,5	4	15	250	370	555	18	STE Basic   Advance

### 6 Resistencias eléctricas

STEAM GENERATOR MODEL	kW	STEAM ROOM (m³)		SIZE OF HEATER (mm)			WEIGHT (kg)	CONTROL
		MIN	MAX	LENGTH	WIDTH	HEIGHT		
STE-90-C1/3	9,0	8	20	335	465	555	23	STE Basic   Advance
STE-120-3	12,0	15	28	335	465	555	23	STE Basic   Advance
STE-150-3	15,0	22	40	335	465	555	23	STE Basic   Advance

### INCLUIDO CON EL GENERADOR DE VAPOR



Sensor de temperatura con cable y soporte para sensor



Salida de vapor (1x incluido hasta 9kW, 2x para superiores)



7,5m RJ12 Cable  
7,5m RJ10 Cable

## Generador de Vapor Series Connection



Classic 2.0



Acero inoxidable táctil

Steam Generator Control

JUMPER  
M = OFF  
1 = OFF  
2 = OFF



Master Steam Generator

1  
JUMPER  
M = ON  
1 = OFF  
2 = OFF



Slave 1 Steam Generator

2  
JUMPER  
M = ON  
1 = ON  
2 = OFF



Slave 2 Steam Generator

3  
JUMPER  
M = ON  
1 = OFF  
2 = ON



Slave 3

4  
JUMPER  
M = ON  
1 = ON  
2 = ON



Slave 4

# Generador de Vapor Controls



## Steam 2.0 (STP-INFACE-V2)

- » Carcasa de acero inoxidable
- » Pantalla digital LED
- » Bomba de aroma, regulador de luz y ventilador
- » Cable RJ12 de 7,5 metros con conectores incluido



## Steam Acero inoxidable táctil (STP-INFACE-SST)

- » Carcasa de acero inoxidable
- » Botones animados
- » Compatible con sistemas domóticos
- » Preparado para alarma de emergencia
- » Modo de espera para mantener el agua caliente hasta la próxima sesión
- » Muestra el código de error
- » Función de autodrenaje
- » Bloqueo de teclas
- » Modo fácil disponible
- » Configuración de fecha y hora
- » Contador de consumo en kW
- » Función de descalcificación
- » Detección de fallo en las resistencias
- » Memoria ante cortes de energía
- » Unidad de temperatura en Celsius o Fahrenheit
- » Encendido automático de luz
- » Encendido automático de ventilador
- » Ajuste de contraste de pantalla LCD
- » Bomba de aroma, regulador de luz y ventilador
- » Sensor de temperatura con cable
- » Soporte de interfaz opcional
- » Cable RJ12 de 7,5 metros con conectores incluido

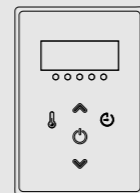

## Steam STE (STE-INFACE-V2)

- » Thick Acero inoxidable Carcasa
- » LED digital display
- » 7,5 meters RJ12 cable with connectors included

## OpcionesAL ITEMS



Bomba de Aroma  
cód.- STP-PUMP



Botón de demanda  
cód.- STP-BTN-2.0



Puerta Vapor  
cód.- ST-746-L | R | I  
go: 790 x 1890mm



Puerta Vapor  
cód.- ST-749-L | R | I  
go: 900 x 2100mm



Soporte para STN-W  
cód.- STW-STAND

- » Para facilitar la instalación del generador de vapor STN-W

## VENTURI PIPES



Tubo Venturi forma L  
cód.- ST-LPIPE



Tubo Venturi Recto  
cód.- ST-PIPE

## Tubo Venturi

- » Genera vapor más suave y delicado
- » Crea nubes de vapor adicionales
- » Evita el ruido de silbido
- » Incluye salida de vapor para dispersar la descarga de vapor
- » Metal grueso de acero inoxidable





[sawo.com](http://sawo.com)

 [SAWO Sauna](#)

 [SAWOsauna](#)

 [SAWO Inc.](#)

 [SAWOSauna](#)

 [SAWOSauna](#)